

Gate Driver Providing Galvanic isolation Series

Isolation voltage 2500Vrms

1ch Gate Driver Providing Galvanic Isolation



**BM6101FV-C**

●General Description

The BM6101FV-C is a gate driver with isolation voltage 2500Vrms, I/O delay time of 350ns, and minimum input pulse width of 180ns, and incorporates the fault signal output functions, undervoltage lockout (UVLO) function, thermal protection function, and short current protection (SCP, DESAT) function.

●Features

- Providing Galvanic Isolation
- Active Miller Clamping
- Fault signal output function (Adjustable output holding time)
- Undervoltage lockout function
- Thermal protection function
- Short current protection function (Adjustable reset time)
- Soft turn-off function for short current protection (Adjustable turn-off time)
- Supporting Negative VEE2

●Key Specifications

- Isolation voltage: 2500Vrms(Max.)
- Maximum gate drive voltage: 24V(Max.)
- I/O delay time: 350ns(Max.)
- Minimum input pulse width: 180ns(Max.)

●Package

SSOP-B20W

W(Typ.) x D(Typ.) x H(Max.)  
6.50mm x 8.10mm x 2.01mm



●Applications

- Automotive isolated IGBT/MOSFET inverter gate drive
- Automotive DC-DC converter
- Industrial inverters system
- UPS system

●Typical Application Circuits

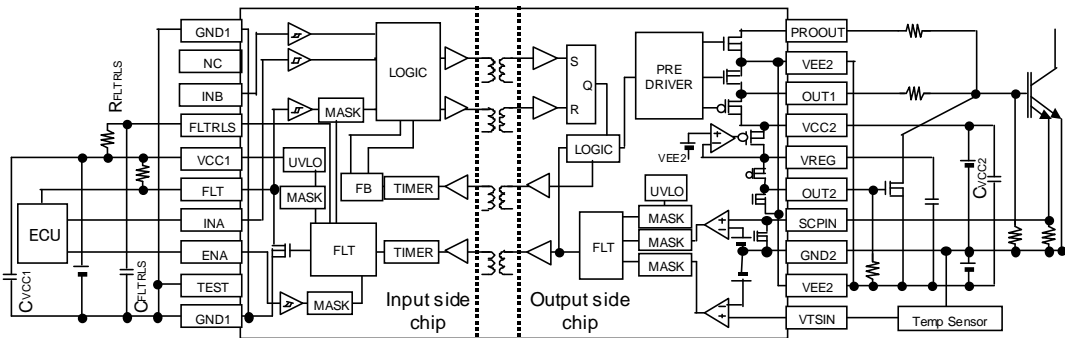

Figure 1. For using 4-pin IGBT (for using SCP function)

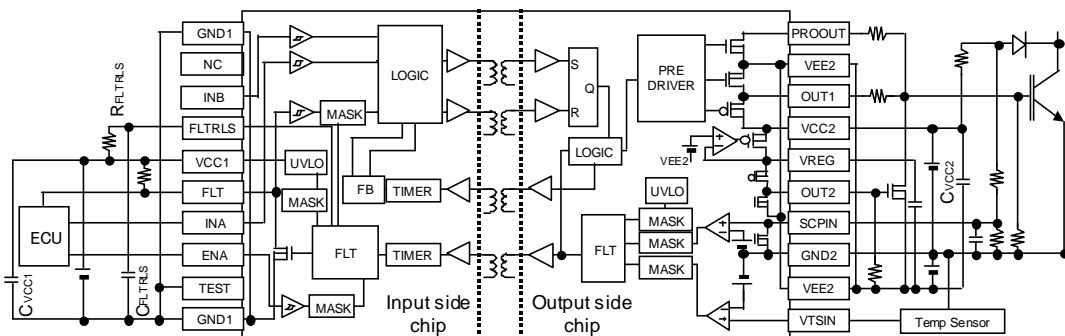
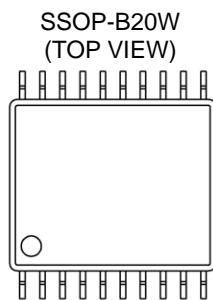

Figure 2. For using 3-pin IGBT (for using DESAT function)

### ● Recommended range of external constants

Pin Name	Symbol	Recommended Value			Unit
		Min.	Typ.	Max.	
FLTRLS	CFLTRLS	-	0.01	0.47	uF
	RFLTRLS	50	200	1000	kΩ
VREG	CVREG	1.0	3.3	10.0	uF
VCC1	CVCC1	0.1	1.0	-	uF
VCC2	CVCC2	0.33	-	-	uF

### ● Pin Configuration



1pin

Figure 3. Pin configuration

### ● Pin Description

Pin No.	Pin Name	Function
1	VTSIN	Thermal detection pin
2	VEE2	Output-side negative power supply pin
3	GND2	Output-side ground pin
4	SCPIN	Short current detection pin
5	OUT2	MOS FET control pin for Miller Clamp
6	VREG	Power supply pin for driving MOS FET for Miller Clamp
7	VCC2	Output-side positive power supply pin
8	OUT1	Output pin
9	VEE2	Output-side negative power supply pin
10	PROOUT	Soft turn-off pin
11	GND1	Input-side ground pin
12	NC	No Connect
13	INB	Invert / non-invert selection pin
14	FLTRLS	Fault output holding time setting pin
15	VCC1	Input-side power supply pin
16	FLT	Fault output pin
17	INA	Control input pin
18	ENA	Input enabling signal input pin
19	TEST	Test mode setting pin
20	GND1	Input-side ground pin

### ●Description of pins and cautions on layout of board

#### 1) VCC1 (Input-side power supply pin)

The VCC1 pin is a power supply pin on the input side. To suppress voltage fluctuations due to the current to drive internal transformers, connect a bypass capacitor between the VCC1 and the GND1 pins.

#### 2) GND1 (Input-side ground pin)

The GND1 pin is a ground pin on the input side.

#### 3) VCC2 (Output-side positive power supply pin)

The VCC2 pin is a positive power supply pin on the output side. To reduce voltage fluctuations due to OUT1 pin output current and due to the current to drive internal transformers, connect a bypass capacitor between the VCC2 and the GND2 pins.

#### 4) VEE2 (Output-side negative power supply pin)

The VEE2 pin is a power supply pin on the output side. To suppress voltage fluctuations due to OUT1 pin output current and due to the current to drive internal transformers, connect a bypass capacitor between the VEE2 and the GND2 pins. To use no negative power supply, connect the VEE2 pin to the GND2 pin.

#### 5) GND2 (Output-side ground pin)

The GND2 pin is a ground pin on the output side. Connect the GND2 pin to the emitter / source of a power device.

#### 6) IN (Control input terminal)

The IN pin is a pin used to determine output logic.

ENA	INB	INA	OUT1
H	X	X	L
L	L	L	L
L	L	H	H
L	H	L	H
L	H	H	L

#### 7) FLT (Fault output pin)

The FLT pin is an open drain pin used to output a fault signal when a fault occurs (i.e., when the undervoltage lockout function (UVLO), short current protection function (SCP) or thermal protection function is activated).

This pin is I/O pin and if L voltage is externally input, the output is set to L status regardless of other input logic. Consequently, be sure to connect the pull-up resistor between VCC1 pin and the FLT pin even if this pin is not used.

Pin	FLT
While in normal operation	Hi-Z
When an Fault occurs (When UVLO, SCP or thermal protection is activated)	L

#### 8) FLTRLS (Fault output holding time setting pin)

The FLTRLS pin is a pin used to make setting of time to hold a Fault signal. Connect a capacitor between the FLTRLS pin and the GND1 pin, and a resistor between it and the VCC1 pin.

The Fault signal is held until the FLTRLS pin voltage exceeds a voltage set with the VFLTRLS parameter. To set holding time to 0 ms, do not connect the capacitor. Short-circuiting the FLTRLS pin to the VCC1 pin will cause a high current to flow in the FLTRLS pin and, in an open state, may cause the IC to malfunction. To avoid such trouble, be sure to connect a resistor between the FLTRLS and the VCC1 pins.

#### 9) OUT1 (Output pin)

The OUT1 pin is a pin used to drive the gate of a power device.

#### 10) OUT2 (MOS FET control pin for Miller Clamp)

The OUT2 pin is a pin for controlling the external MOS switch for preventing increase in gate voltage due to the miller current of the power device connected to OUT1 pin.

#### 11) VREG (Power supply pin for driving MOS FET for Miller Clamp)

The VREG pin is a power supply pin for driving MOS FET for Miller Clamp. Be sure to connect a capacitor between VREG pin and VEE2 pin for preventing the oscillation and to reduce voltage fluctuations due to OUT2 pin output current.

#### 12) PROOUT (Soft turn-off pin)

The PROOUT pin is a pin used to put the soft turn-off function of a power device in operation when the SCP function is activated. This pin combines with the gate voltage monitoring pin for Miller Clamp.

#### 13) SCPIN (Short current detection pin)

The SCPIN pin is a pin used to detect current for short current protection. When the SCPIN pin voltage exceeds a voltage set with the VSCDET parameter, the SCP function will be activated. This may cause the IC to malfunction in an open state. To avoid such trouble, short-circuit the SCPIN pin to the GND2 pin if the short current protection is not used. In order to prevent the wrong detection due to noise, the noise mask time  $t_{SCPMASK}$  is set.

14) VTSIN (Thermal detection pin)

The VTSIN pin is a temperature sensor voltage input pin, which can be used for thermal protection of an output device. If VTSIN pin voltage becomes  $V_{TSDDET}$  or less, OUT pin is set to L. In the open status, the IC may malfunction, so be sure to supply the VTSPIN more than  $V_{TSDDET}$  if the thermal protection function is not used. In order to prevent the wrong detection due to noise, the noise mask time  $t_{TSMASK}$  is set.

●Description of functions and examples of constant setting

1) Miller Clamp function

When  $OUT1=L$  and PROOUT pin voltage  $< V_{OUT2ON}$ , H is output from OUT2 pin and the external MOS switch is turned ON. When  $OUT1=H$ , L is output from OUT2 pin and the external MOS switch is turned OFF. While the short-circuit protection function is activated, L is output from OUT2 pin and the external MOS switch is turned OFF.

Short current	SCPIN	IN	PROOUT	OUT2
Detected	Not less than $V_{SCDET}$	X	X	L
Not detected	X	L	Not less than $V_{OUT2ON}$	Hi-Z
	X	L	Not more than $V_{OUT2ON}$	H
	X	H	X	L

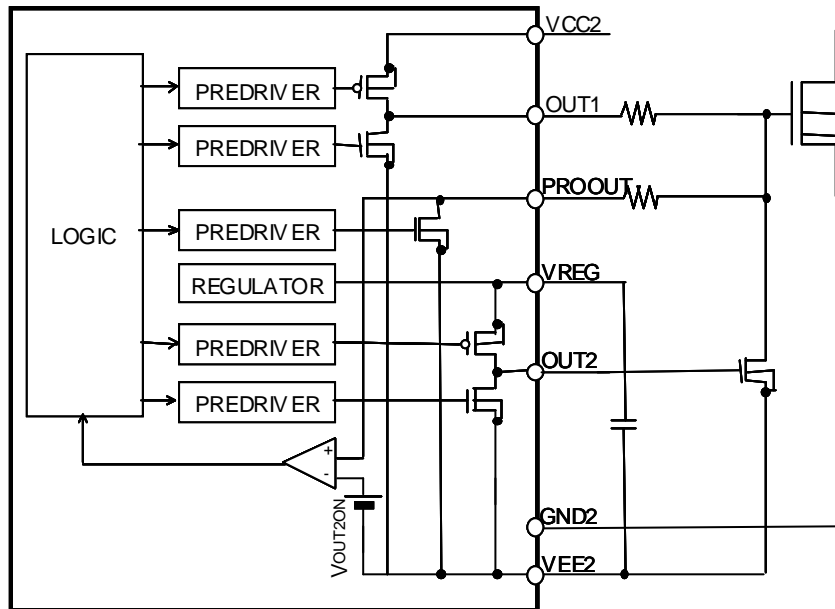

Figure 4. Block diagram of Miller Clamp function

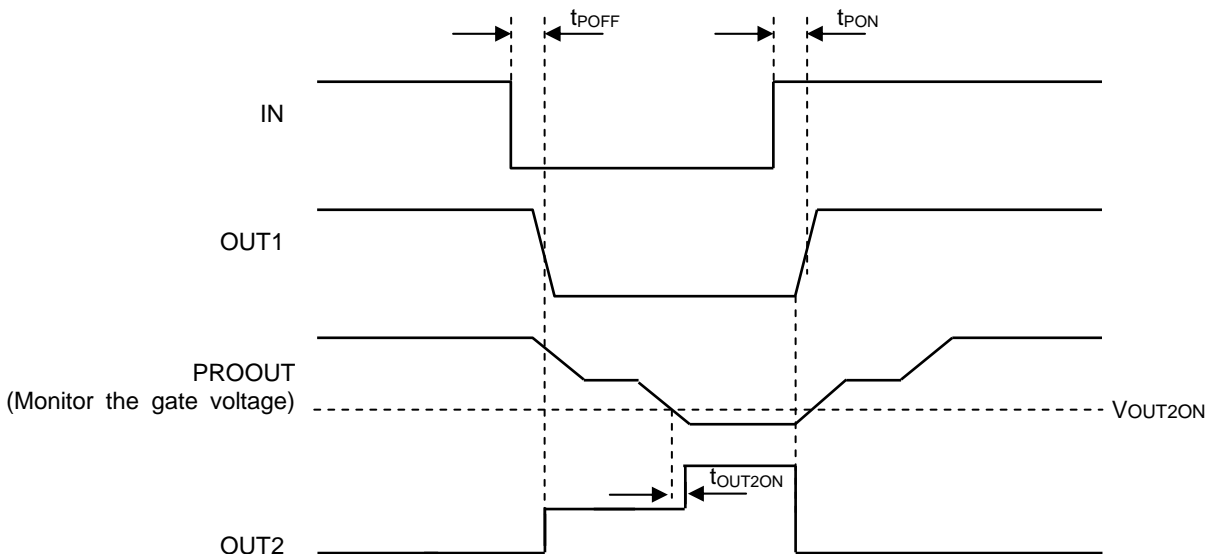

Figure 5. Timing chart of Miller Clamp function

2) Fault status output

This function is used to output a fault signal from the FLT pin when a fault occurs (i.e., when the undervoltage lockout function (UVLO), short current protection function (SCP) or thermal protection function is activated) and hold the Fault signal until the set Fault output holding time is completed. The Fault output holding time  $t_{FLTRLS}$  is given as the following equation with the settings of capacitor  $C_{FLTRLS}$  and resistor  $R_{FLTRLS}$  connected to the FLTRLS pin. For example, when  $C_{FLTRLS}$  is set to  $0.01\mu F$  and  $R_{FLTRLS}$  is set to  $200k\Omega$ , the holding time will be set to 2 ms.

$$t_{FLTRLS} [ms] = C_{FLTRLS} [\mu F] \cdot R_{FLTRLS} [k\Omega]$$

To set the fault output holding time to "0" ms, only connect the resistor  $R_{FLTRLS}$ .

Status	FLT pin
Normal	Hi-Z
Fault occurs	L

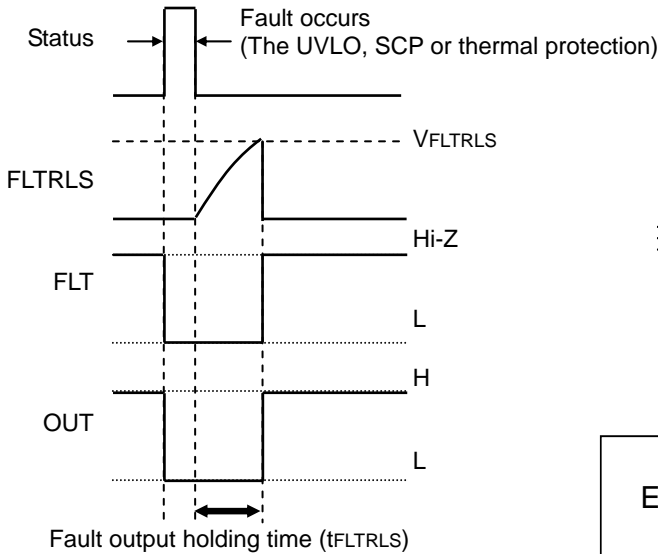

Figure 6. Fault Status Output Timing Chart

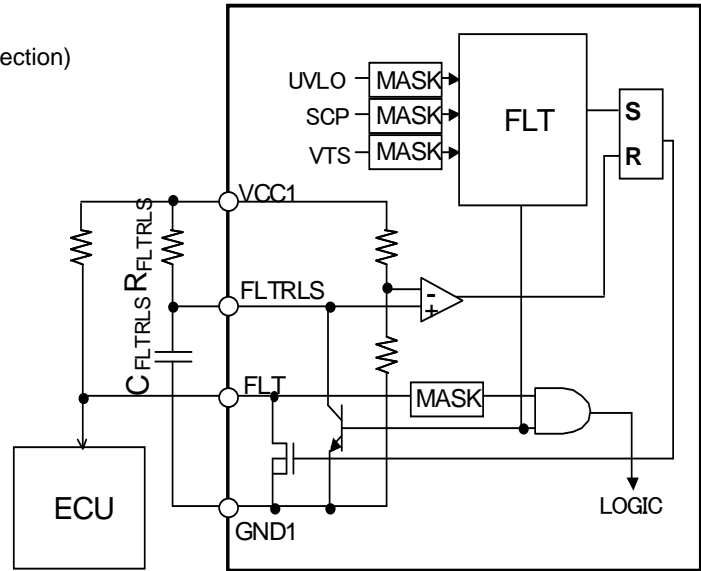

Figure 7. Fault Output Block Diagram

3) Undervoltage Lockout (UVLO) function

The BM6101FV-C incorporates the undervoltage lockout (UVLO) function both on the low and the high voltage sides. When the power supply voltage drops to the UVLO ON voltage, the OUT pin and the FLT pin both will output the "L" signal. When the power supply voltage rises to the UVLO OFF voltage, these pins will be reset. However, during the fault output holding time set in "2) Fault status output" section, the OUT pin and the FLT pin will hold the "L" signal. In addition, to prevent malfunctions due to noises, mask time  $t_{UVLO1MSK}$  and  $t_{UVLO2MSK}$  are set on both low and high voltage sides.

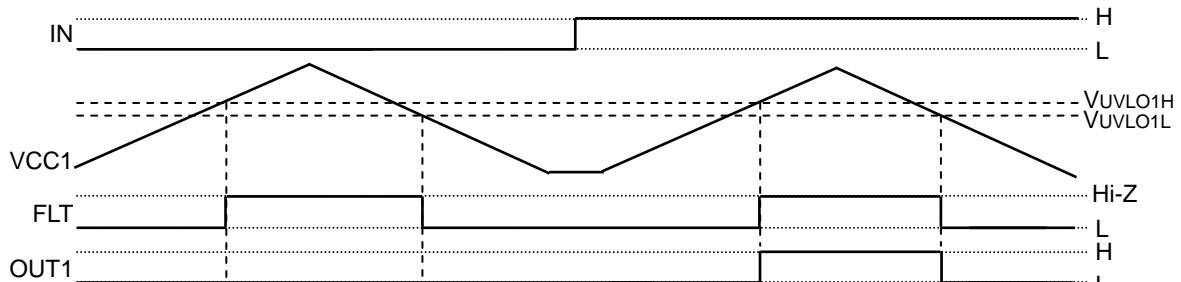

Figure 8. Input-side UVLO Function Operation Timing Chart

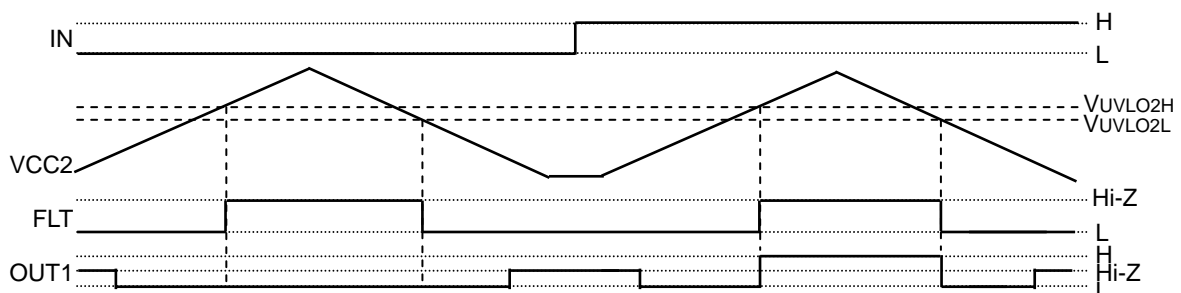

Figure 9. Output-side UVLO Operation Timing Chart

4) Short current protection function (SCP, DESAT)

When the SCPIN pin voltage exceeds a voltage set with the VSCDET parameter, the SCP function will be activated. When the SCP function is activated, the OUT1 pin voltage will be set to the “Hi-Z” level first, and then the PROOUT pin voltage to the “L” level (soft turn-off). Next, after  $t_{STO}$  has passed after the short-circuit current falls below the threshold value, OUT pin becomes L and PROOUT pin becomes L. Finally, when the fault output holding time set in “2) fault status output” section on page 5 is completed, the SCP function will be released.

When OUT1=L or Hi-Z, internal MOSFET connected to SCPIN pin turns ON to discharge C<sub>BLANK</sub>. When OUT1=H, internal MOSFET connected to SCPIN turns OFF.

V<sub>COLLECTOR</sub>/V<sub>DRAIN</sub> which Desaturation Protection starts operation (V<sub>DESAT</sub>) and the blanking time (t<sub>BLANK</sub>) can be calculated by the formula below;

$$V_{DESAT} [V] = V_{SCDET} \cdot \frac{R3 + R2}{R3} - V_{F_d}$$

$$V_{CC2_{MIN}} [V] > V_{SCDET} \cdot \frac{R3 + R2 + R1}{R3}$$

$$t_{BLANK_{external}} [s] = -\frac{R2 + R1}{R3 + R2 + R1} \cdot R3 \cdot (C_{BLANK} + 27 \cdot 10^{-12}) \cdot \ln\left(1 - \frac{R3 + R2 + R1}{R3} \cdot \frac{V_{SCDET}}{V_{CC2}}\right) + 0.65 \cdot 10^{-6}$$

V <sub>DESAT</sub>	Reference Value		
	R1	R2	R3
4.0V	15 kΩ	39 kΩ	6.8 kΩ
4.5V	15 kΩ	43 kΩ	6.8 kΩ
5.0V	15 kΩ	36 kΩ	5.1 kΩ
5.5V	15 kΩ	39 kΩ	5.1 kΩ
6.0V	15 kΩ	43 kΩ	5.1 kΩ
6.5V	15 kΩ	62 kΩ	6.8 kΩ
7.0V	15 kΩ	68 kΩ	6.8 kΩ
7.5V	15 kΩ	82 kΩ	7.5 kΩ
8.0V	15 kΩ	91 kΩ	8.2 kΩ
8.5V	15 kΩ	82 kΩ	6.8 kΩ
9.0V	15 kΩ	130 kΩ	10 kΩ
9.5V	15 kΩ	91 kΩ	6.8 kΩ
10.0V	15 kΩ	130 kΩ	9.1 kΩ

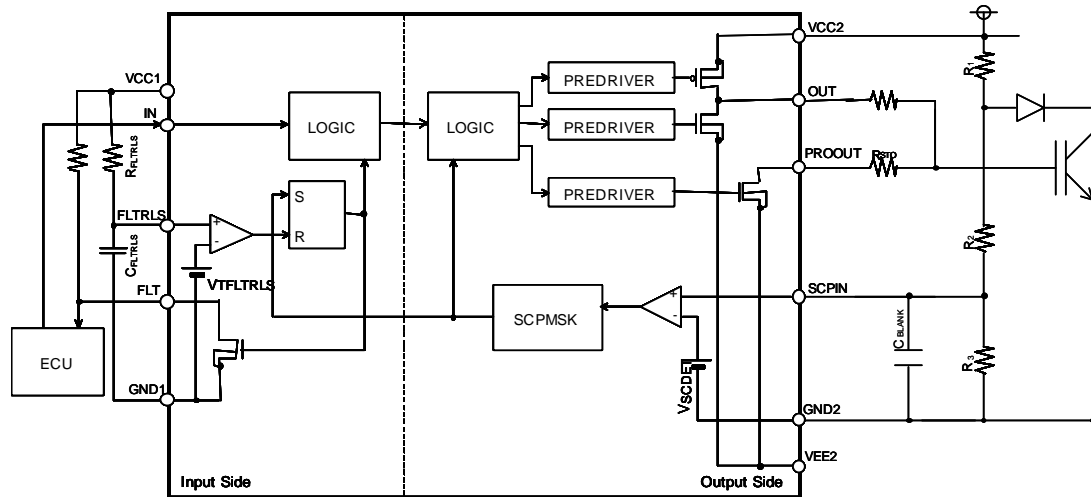
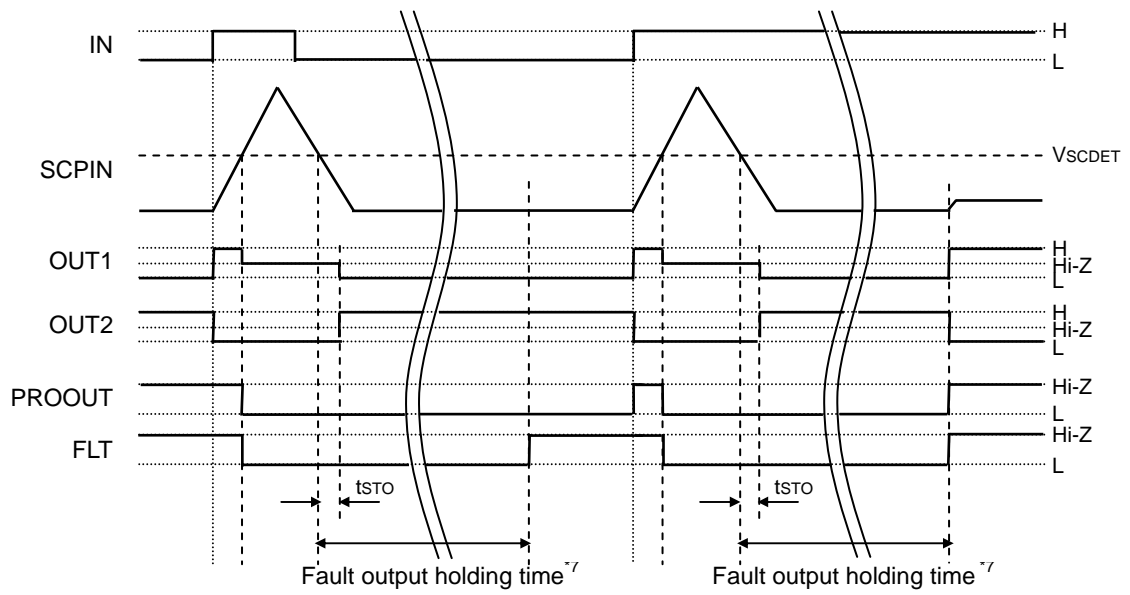
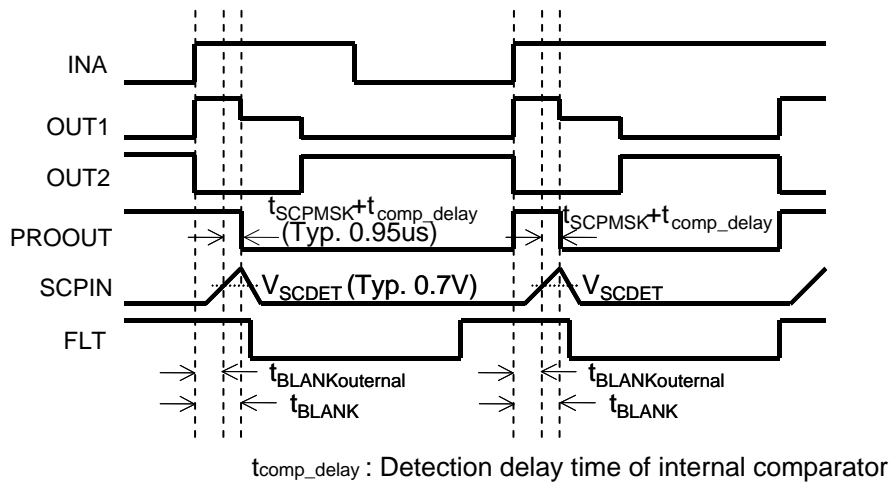

Figure 10. Block Diagram for DESAT



\*7: "2) Fault status output" section on page 5

Figure 11. SCP Operation Timing Chart



t<sub>comp\_delay</sub> : Detection delay time of internal comparator

Figure 12. DESAT sequence

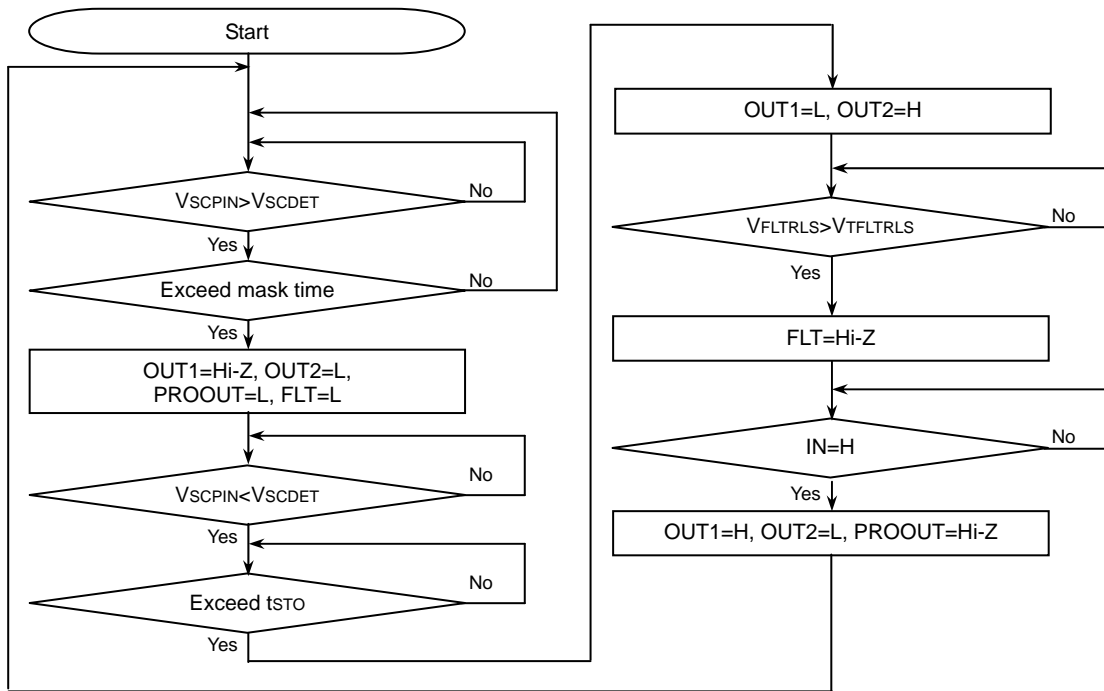

Figure 13. SCP Operation Status Transition Diagram

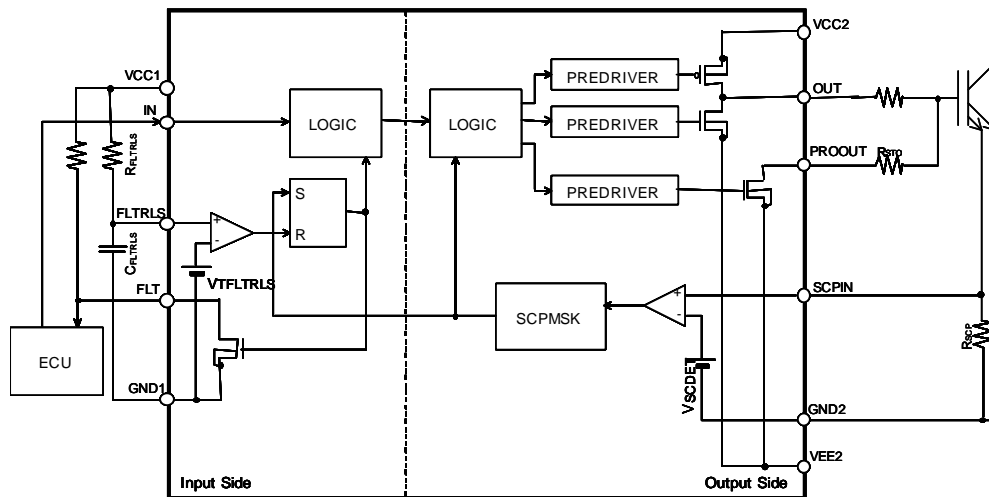

Figure 14. Block Diagram for SCP



5) I/O condition table

No.	Status	Input									Output			
		VCC1	VCC2	V T S I N	S C P I N	F L T	E N A	I N B	I N A	P R O O U T	O U T 1	O U T 2	P R O O U T	F L T
1	SCP	X	X	X	H	X	X	X	X	X	Hi-Z	L	L	L
2	VCC1UVLO	UVLO	X	X	L	X	X	X	X	H	L	Hi-Z	Hi-Z	L
3		UVLO	X	X	L	X	X	X	X	L	L	H	Hi-Z	L
4	VCC2UVLO	X	UVLO	X	L	X	X	X	X	H	L	Hi-Z	Hi-Z	L
5		X	UVLO	X	L	X	X	X	X	L	L	H	Hi-Z	L
6	Thermal protection	○	○	L	L	X	X	X	X	H	L	Hi-Z	Hi-Z	L
7		○	○	L	L	X	X	X	X	L	L	H	Hi-Z	L
8	FLT external input	○	○	H	L	L	X	X	X	H	L	Hi-Z	Hi-Z	Hi-Z
9		○	○	H	L	L	X	X	X	L	L	H	Hi-Z	Hi-Z
10	Disable	○	○	H	L	H	H	X	X	H	L	Hi-Z	Hi-Z	Hi-Z
11		○	○	H	L	H	H	X	X	L	L	H	Hi-Z	Hi-Z
12	Non-invert operation L input	○	○	H	L	H	L	L	L	H	L	Hi-Z	Hi-Z	Hi-Z
13		○	○	H	L	H	L	L	L	L	L	H	Hi-Z	Hi-Z
14	Non-invert operation H input	○	○	H	L	H	L	L	H	X	H	L	Hi-Z	Hi-Z
15	Invert operation L input	○	○	H	L	H	L	H	L	X	H	L	Hi-Z	Hi-Z
16	Invert operation H input	○	○	H	L	H	L	H	H	H	L	Hi-Z	Hi-Z	Hi-Z
17		○	○	H	L	H	L	H	H	L	L	H	Hi-Z	Hi-Z

○: VCC1 or VCC2 &gt; UVLO, X: Don't care

6) Power supply startup / shutoff sequence

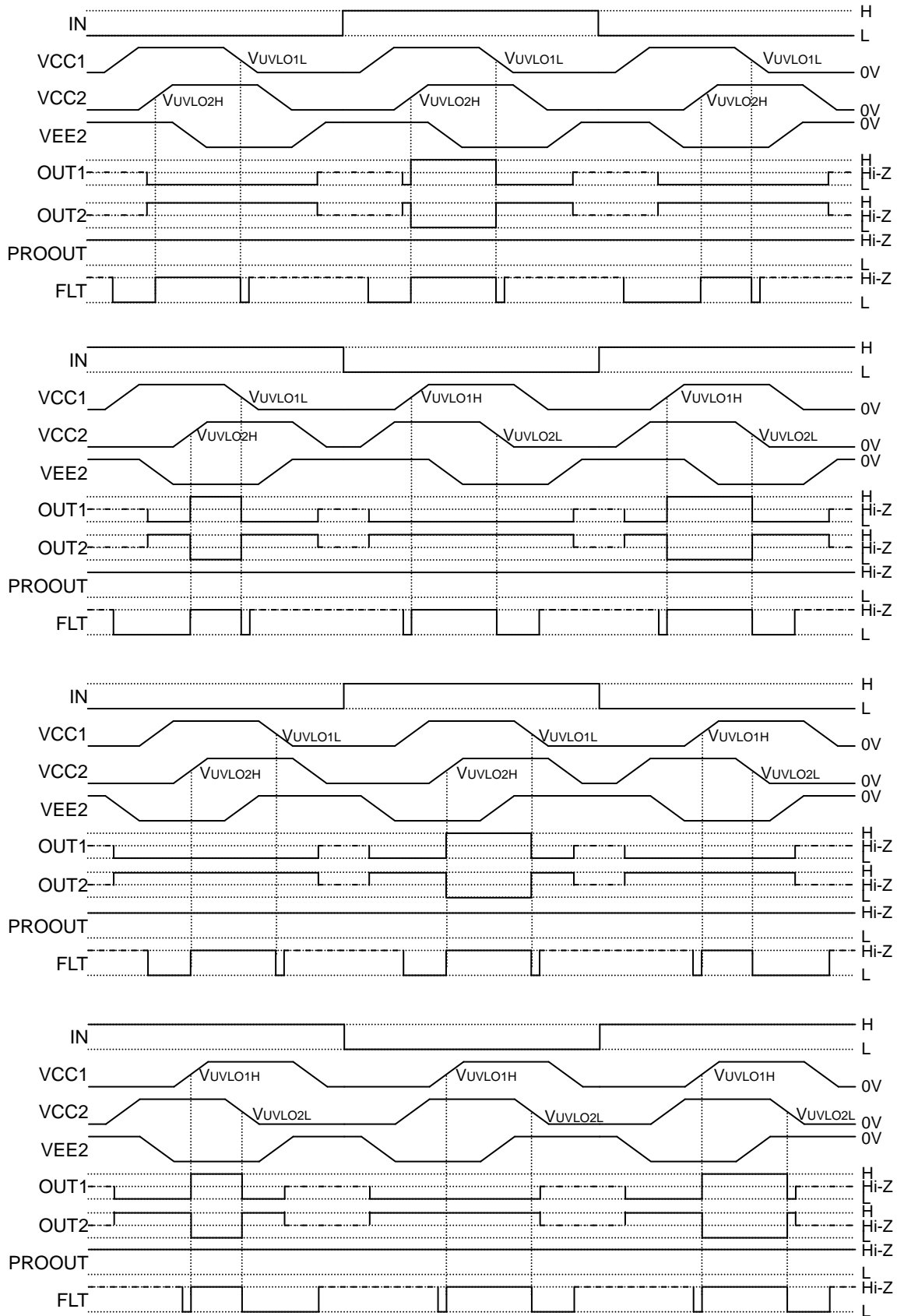

----- : Since the VCC2 to VEE2 pin voltage is low and the output MOS does not turn ON, the output pins become Hi-Z conditions.  
 ----- : Since the VCC1 pin voltage is low and the FLT output MOS does not turn ON, the output pins become Hi-Z conditions.

Figure 15. Power supply startup / shutoff sequence

### ● Absolute Maximum Ratings

Parameter	Symbol	Limits	Unit
Input-side supply voltage	$V_{CC1}$	-0.3 to +7.0 <sup>*1</sup>	V
Output-side positive supply voltage	$V_{CC2}$	-0.3 to +30.0 <sup>*2</sup>	V
Output-side negative supply voltage	$V_{EE2}$	-15.0 to +0.3 <sup>*2</sup>	V
Maximum difference between output-side positive and negative voltages	$V_{MAX2}$	36.0	V
INA, INB, ENA pin input voltage	$V_{IN}$	-0.3 to +VCC1+0.3 or 7.0 <sup>*1</sup>	V
FLT pin input voltage	$V_{FLT}$	-0.3 to +VCC1+0.3 or 7.0 <sup>*1</sup>	V
FLTRLS pin input voltage	$V_{FLTRLS}$	-0.3 to +VCC1+0.3 or 7.0 <sup>*1</sup>	V
VTSIN pin input voltage	$V_{VTSIN}$	-0.3 to +10.0 <sup>*2</sup>	V
SCPIN pin input voltage	$V_{SCPIN}$	-0.3 to +10.0 <sup>*2</sup>	V
VREG pin output current	$I_{VREG}$	10	mA
OUT1 pin output current (DC)	$I_{OUT1}$	0.4 <sup>*3</sup>	A
OUT1 pin output current (Peak 1us)	$I_{OUT1PEAK}$	5.0	A
OUT2 pin output current (DC)	$I_{OUT2}$	0.1 <sup>*3</sup>	A
OUT2 pin output current (Peak 1us)	$I_{OUT2PEAK}$	1	A
PROOUT pin output current	$I_{PROOUT}$	0.2 <sup>*3</sup>	A
FLT output current	$I_{FLT}$	10	mA
Power dissipation	$P_d$	1.19 <sup>*4</sup>	W
Operating temperature range	$T_{opr}$	-40 to +125	°C
Storage temperature range	$T_{stg}$	-55 to +150	°C
Junction temperature	$T_{jmax}$	+150	°C

\*1 Relative to GND1.

\*2 Relative to GND2.

\*3 Should not exceed  $P_d$  and  $T_j=150^{\circ}\text{C}$ .\*4 Derate above  $T_a=25^{\circ}\text{C}$  at a rate of 9.5mW/°C. Mounted on a glass epoxy of 70 mm × 70 mm × 1.6 mm.

### ● Recommended Operating Ratings

Parameter	Symbol	Min.	Max.	Units
Input-side supply voltage	$V_{CC1}$ <sup>*5</sup>	4.5	5.5	V
Output-side positive supply voltage	$V_{CC2}$ <sup>*6</sup>	14	24	V
Output-side negative supply voltage	$V_{EE2}$ <sup>*6</sup>	-12	0	V
Maximum difference between output-side positive and negative voltages	$V_{MAX2}$	14	32	V
VTSIN pin input voltage	$V_{VTSIN}$ <sup>*6</sup>	0	5	V

\*5 Relative to GND1.

\*6 Relative to GND2.

### ● Insulation related characteristics

Parameter	Symbol	Characteristic	Units
Insulation Resistance ( $V_{IO}=500\text{V}$ )	$R_s$	$>10^9$	$\Omega$
Insulation Withstand Voltage / 1min	$V_{ISO}$	2500	Vrms
Insulation Test Voltage / 1sec	$V_{ISO}$	3000	Vrms

### ●Electrical Characteristics

(Unless otherwise specified  $T_a=-40^{\circ}\text{C}$  to  $125^{\circ}\text{C}$ ,  $V_{CC1}=4.5\text{V}$  to  $5.5\text{V}$ ,  $V_{CC2}=14\text{V}$  to  $24\text{V}$ ,  $V_{EE2}=-12\text{V}$  to  $0\text{V}$ )

Parameter	Symbol	Min.	Typ.	Max.	Unit	Conditions
<b>General</b>						
Input side circuit current 1	$I_{CC1}$	0.20	0.45	0.70	mA	OUT=L
Input side circuit current 2	$I_{CC12}$	0.20	0.45	0.70	mA	OUT=H
Input side circuit current 3	$I_{CC13}$	1.2	2.0	2.8	mA	INA=10kHz, Duty=50%
Input side circuit current 4	$I_{CC14}$	2.1	3.5	4.9	mA	INA=20kHz, Duty=50%
Output side circuit current 1	$I_{CC21}$	1.9	3.2	4.5	mA	VCC2=14V, OUT=L
Output side circuit current 2	$I_{CC22}$	1.3	2.1	2.9	mA	VCC2=14V, OUT=H
Output side circuit current 3	$I_{CC23}$	2.1	3.5	4.9	mA	VCC2=18V, OUT=L
Output side circuit current 4	$I_{CC24}$	1.4	2.4	3.4	mA	VCC2=18V, OUT=H
Output side circuit current 5	$I_{CC25}$	2.4	4.0	5.6	mA	VCC2=24V, OUT=H
Output side circuit current 6	$I_{CC26}$	1.6	2.7	3.8	mA	VCC2=24V, OUT=L
<b>Logic block</b>						
Logic high level input voltage	$V_{INH}$	$0.7 \times V_{CC1}$	-	$V_{CC1}$	V	INA, INB, ENA, FLT
Logic low level input voltage	$V_{INL}$	0	-	$0.3 \times V_{CC1}$	V	INA, INB, ENA, FLT
Logic pull-down resistance	$R_{IND}$	25	50	100	k $\Omega$	INA, INB
Logic pull-up resistance	$R_{INU}$	25	50	100	k $\Omega$	ENA
Logic input mask time	$t_{INMSK}$	80	130	180	ns	INA, INB
ENA, FLT mask time	$t_{FLTMSK}$	4	10	20	$\mu\text{s}$	ENA, FLT
<b>Output</b>						
OUT1 ON resistance (Source)	$R_{ONH}$	0.7	1.8	4.0	$\Omega$	$I_{OUT}=40\text{mA}$
OUT1 ON resistance (Sink)	$R_{ONL}$	0.4	0.9	2.0	$\Omega$	$I_{OUT}=40\text{mA}$
OUT1 maximum current	$I_{OUTMAX}$	3.0	4.5	-	A	VCC2=18V Design assurance
PROOUT ON resistance	$R_{ONPRO}$	0.4	0.9	2.0	$\Omega$	$I_{PROOUT}=40\text{mA}$
Turn ON time	$t_{PON}$	180	265	350	ns	
Turn OFF time	$t_{POFF}$	180	265	350	ns	
Propagation distortion	$t_{PDIST}$	-60	0	60	ns	$t_{POFF} - t_{PON}$
Rise time	$t_{RISE}$	-	50	100	ns	10nF between OUT1-VEE2
Fall time	$t_{FALL}$	-	50	100	ns	10nF between OUT1-VEE2
OUT2 ON resistance (Source)	$R_{ON2H}$	2.0	4.5	9.0	$\Omega$	$I_{OUT2}=40\text{mA}$
OUT2 ON resistance (Sink)	$R_{ON2L}$	1.5	3.5	7.0	$\Omega$	$I_{OUT2}=40\text{mA}$
OUT2 ON threshold voltage	$V_{OUT2ON}$	1.8	2	2.2	V	Relative to VEE2
OUT2 output delay time	$t_{OUT2ON}$	-	15	50	ns	
VREG output voltage	$V_{REG}$	9	10	11	V	Relative to VEE2
Common Mode Transient Immunity	CM	100	-	-	kV/ $\mu\text{s}$	Design assurance
<b>Protection functions</b>						
VCC1 UVLO OFF voltage	$V_{UVLO1H}$	4.05	4.25	4.45	V	
VCC1 UVLO ON voltage	$V_{UVLO1L}$	3.95	4.15	4.35	V	
VCC1 UVLO mask time	$t_{UVLO1MSK}$	4	10	30	$\mu\text{s}$	
VCC2 UVLO OFF voltage	$V_{UVLO2H}$	11.5	12.5	13.5	V	
VCC2 UVLO ON voltage	$V_{UVLO2L}$	10.5	11.5	12.5	V	
VCC2 UVLO mask time	$t_{UVLO2MSK}$	4	10	30	$\mu\text{s}$	
SCPIN Input voltage	$V_{SCPIN}$	-	0.1	0.22	V	$I_{SCPIN}=1\text{mA}$
SCP detection voltage	$V_{SCDET}$	0.665	0.700	0.735	V	
SCP detection mask time	$t_{SCPMASK}$	0.55	0.8	1.05	$\mu\text{s}$	
Soft turn OFF release time	$t_{STO}$	30		110	$\mu\text{s}$	
Thermal detection voltage	$V_{TSDET}$	1.60	1.70	1.80	V	
Thermal detection mask time	$t_{TSMASK}$	4	10	30	$\mu\text{s}$	
FLT output low voltage	$V_{FLTL}$	-	0.18	0.40	V	$I_{FLT}=5\text{mA}$
FLTRLS threshold	$V_{FLTRLS}$	$0.64 \times V_{CC1}$ -0.1	$0.64 \times V_{CC1}$	$0.64 \times V_{CC1}$ +0.1	V	

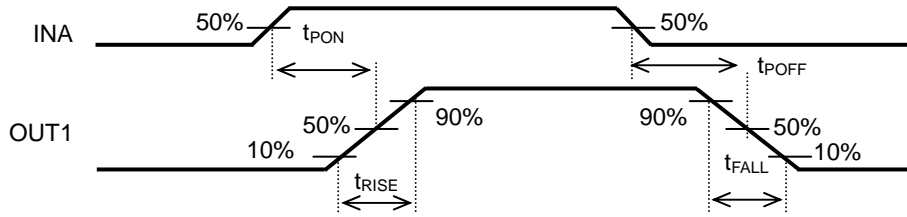

Figure 16. INA-OUT1 Timing Chart

● Typical Performance Curves

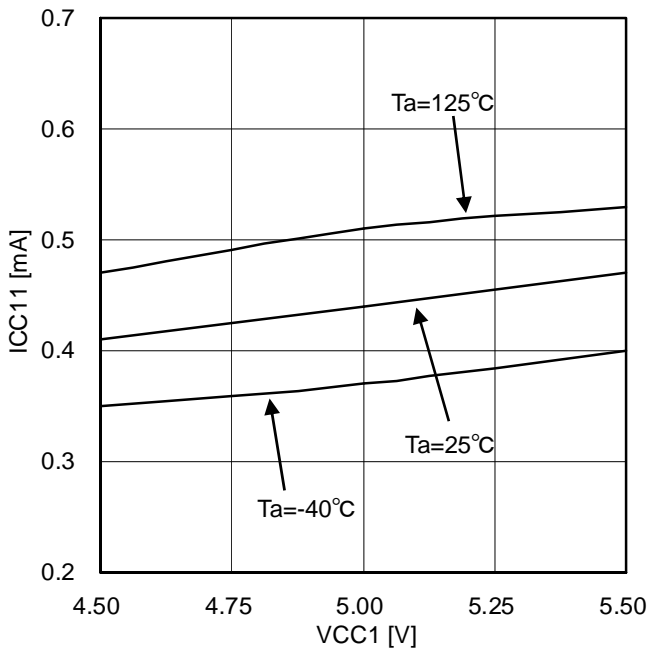

Figure 17. Input side circuit current (at OUT1=L)

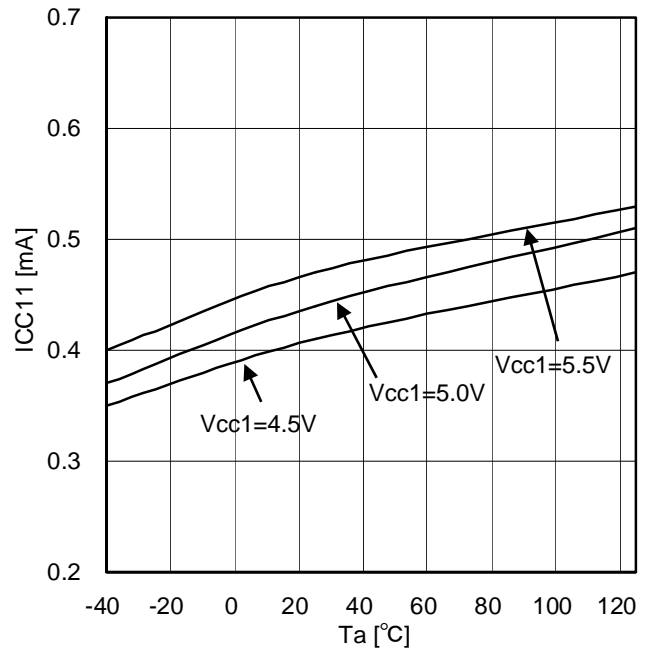

Figure 18. Input side circuit current (at OUT1=L)

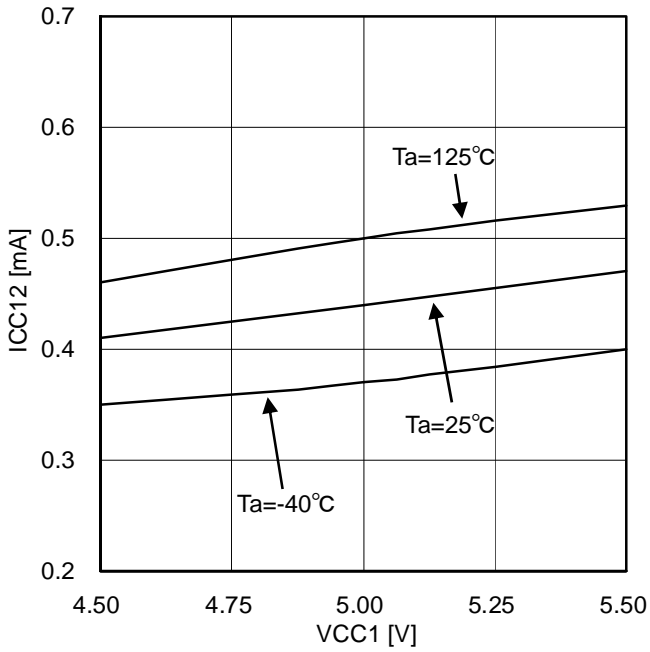

Figure 19. Input side circuit current (at OUT1=H)

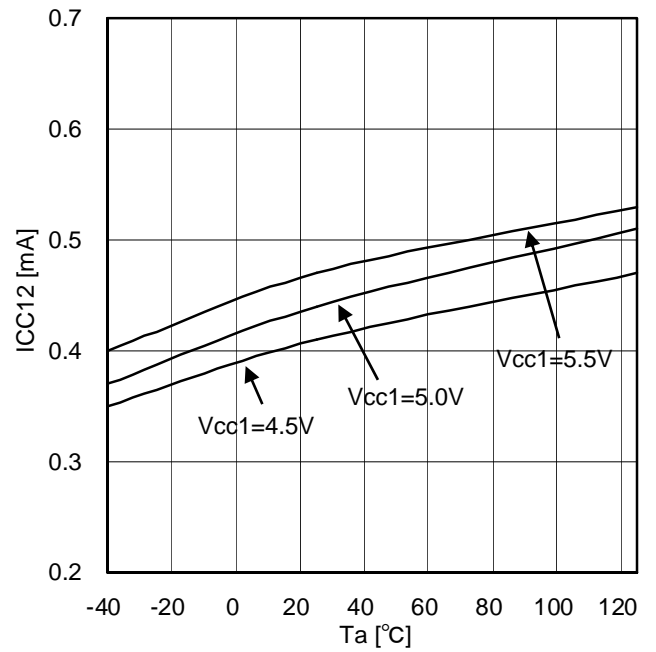

Figure 20. Input side circuit current (at OUT1=H)

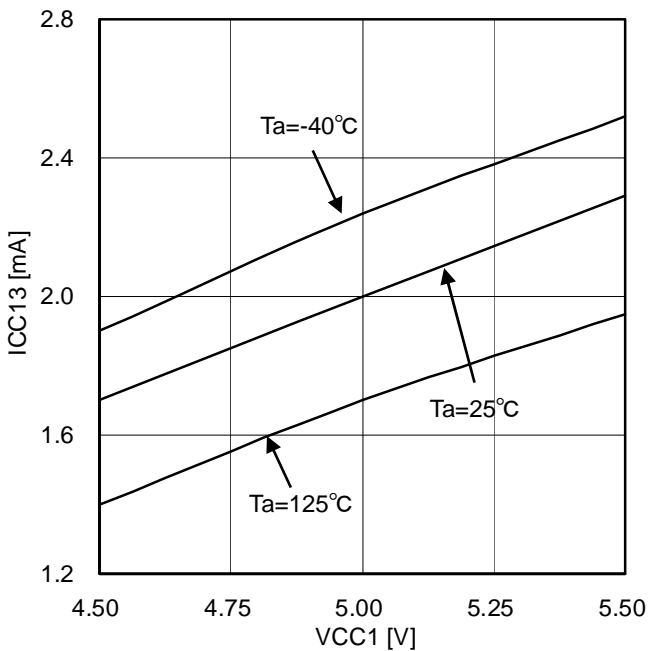

Figure 21. Input side circuit current (at INA=10kHz and Duty=50%)

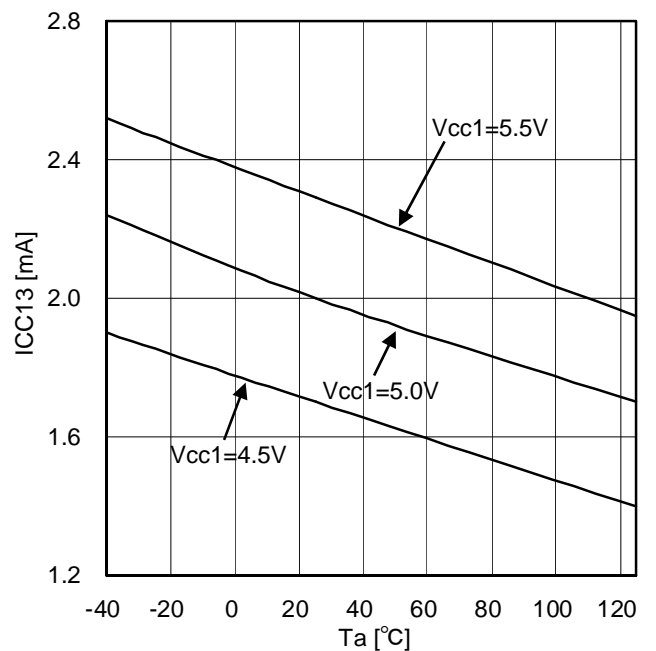

Figure 22. Input side circuit current (at INA=10kHz and Duty=50%)

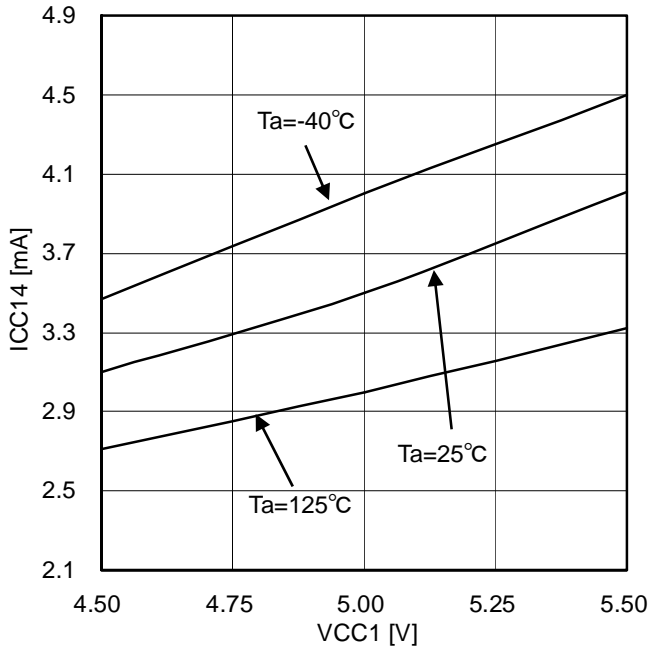

Figure 23. Input side circuit current (at INA=20kHz and Duty=50%)

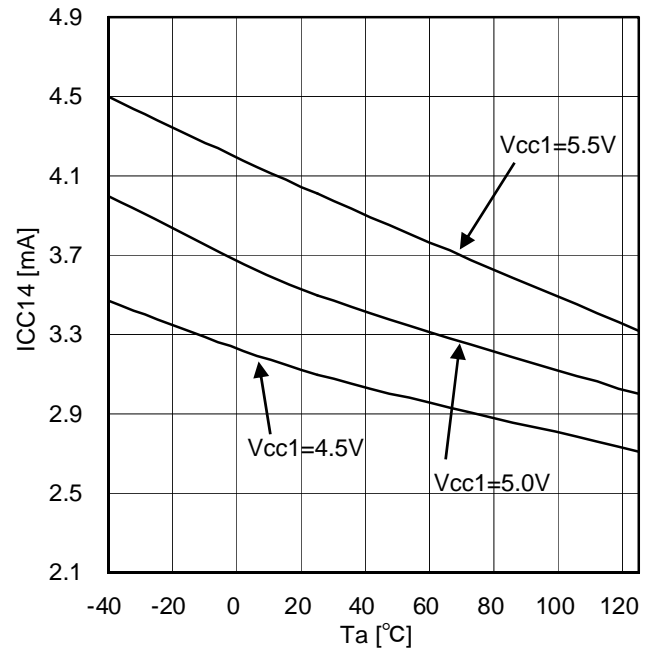

Figure 24. Input side circuit current (at INA=20kHz and Duty=50%)

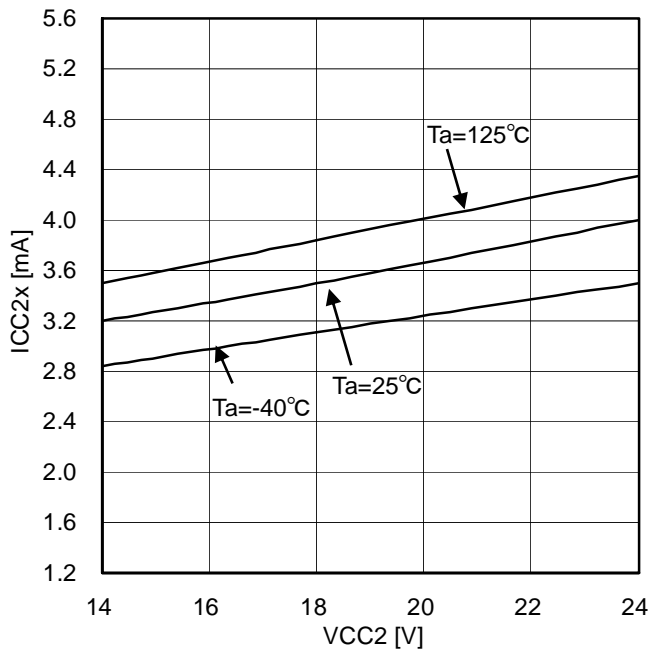

Figure 25. Output side circuit current (at OUT1=L)

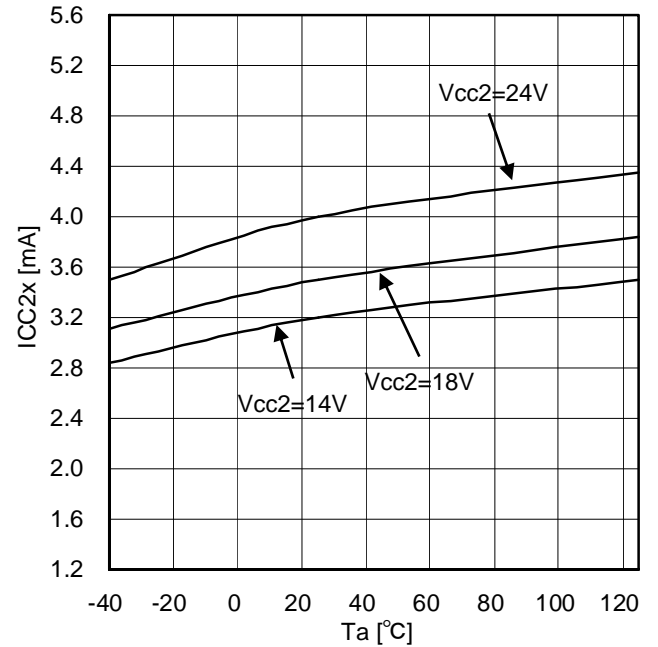

Figure 26. Output side circuit current (at OUT1=L)

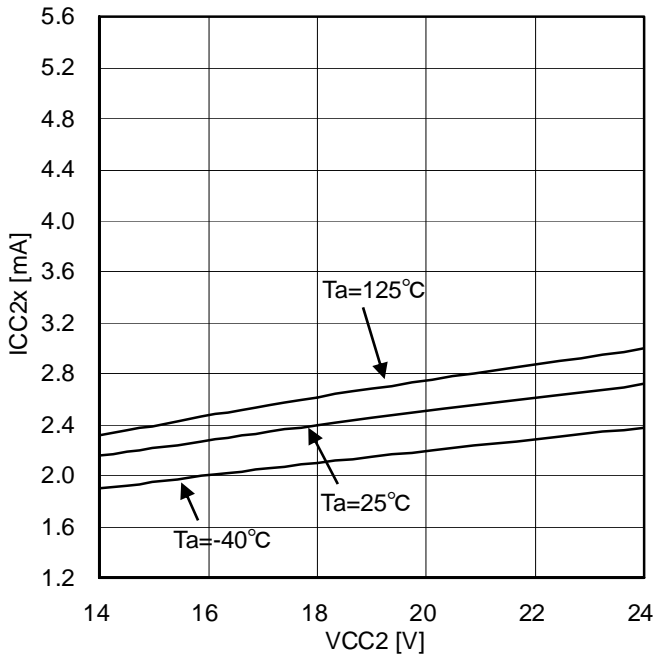

Figure 27. Output side circuit current (at OUT1=H)

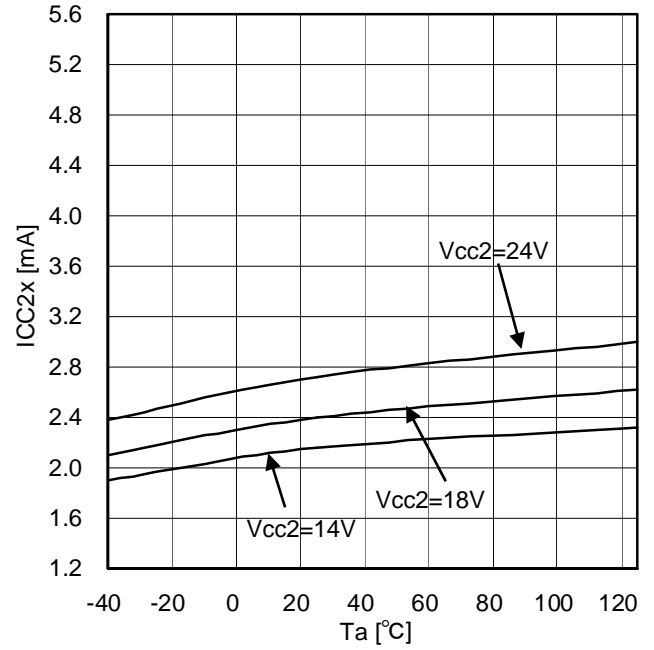

Figure 28. Output side circuit current (at OUT1=H)

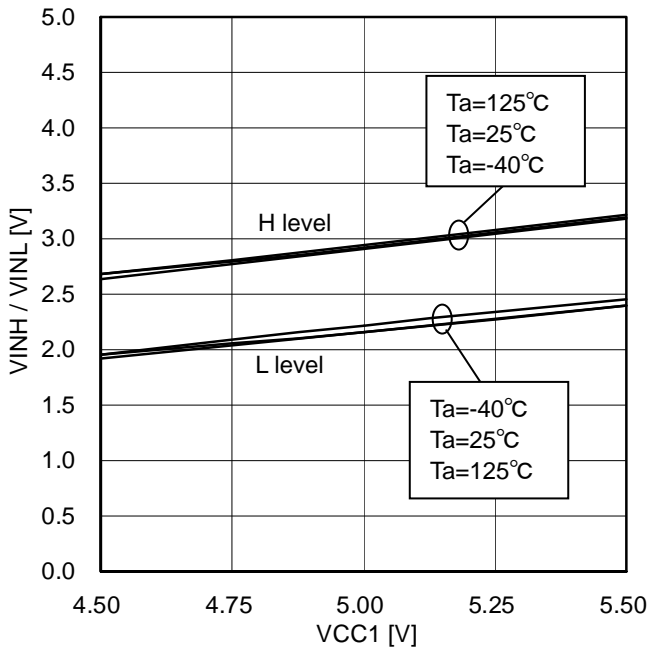

Figure 29. Logic (INA/INB/ENA) High/Low level input voltage

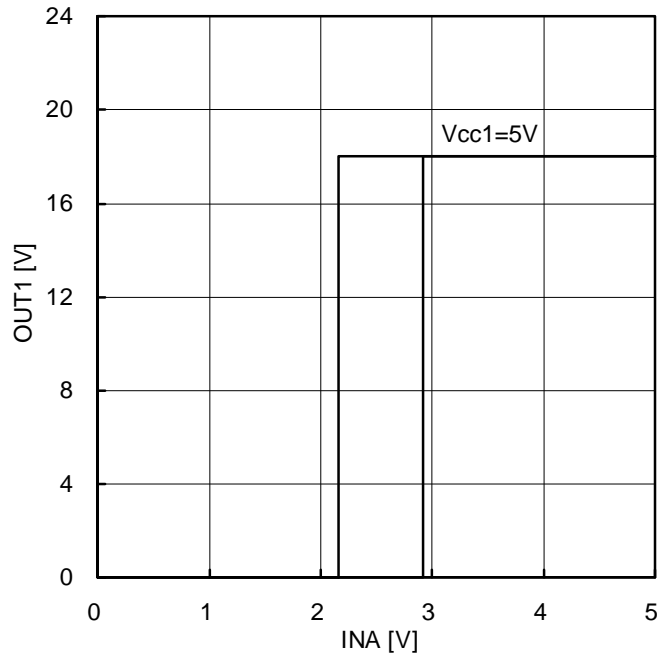

Figure 30. Logic (INA/INB/ENA) High/Low level input voltage at Ta=25°C



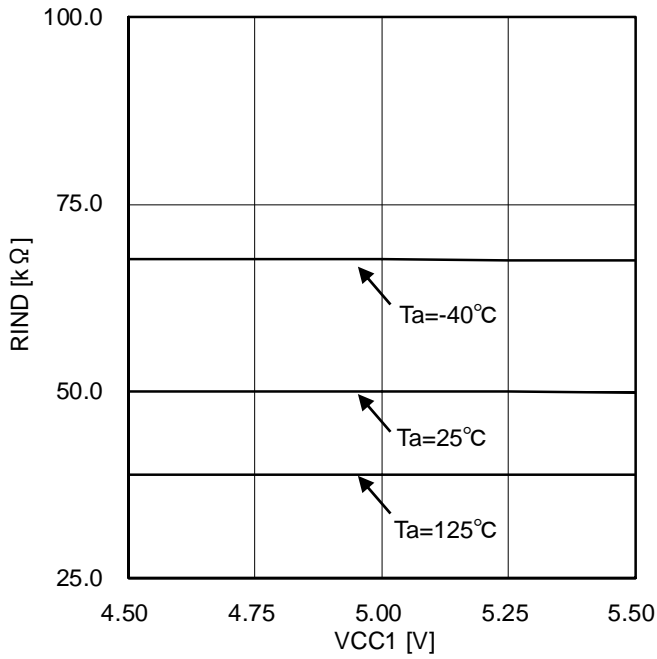

Figure 31. Logic pull-down resistance

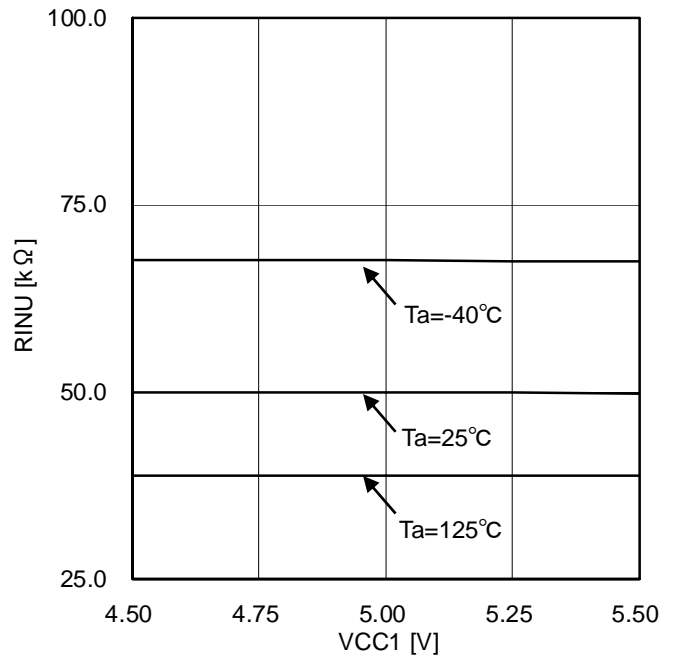

Figure 32. Logic pull-up resistance

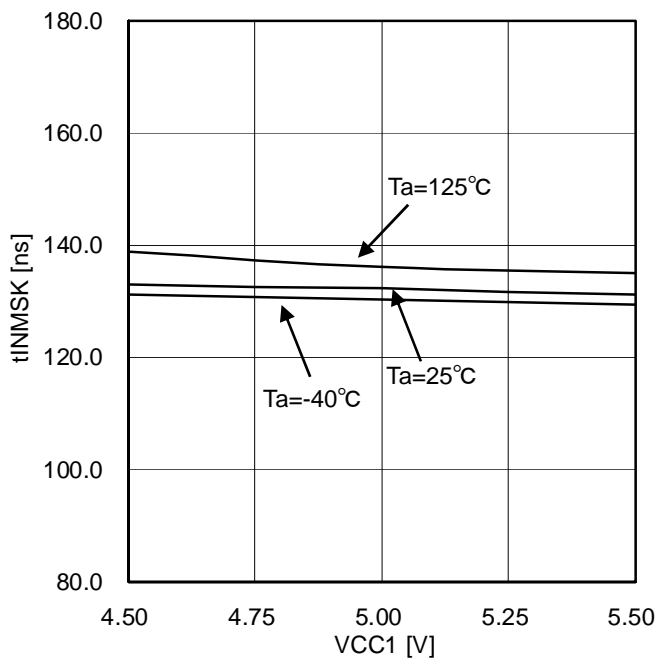

Figure 33. Logic (INA/INB) input mask time (High pulse)

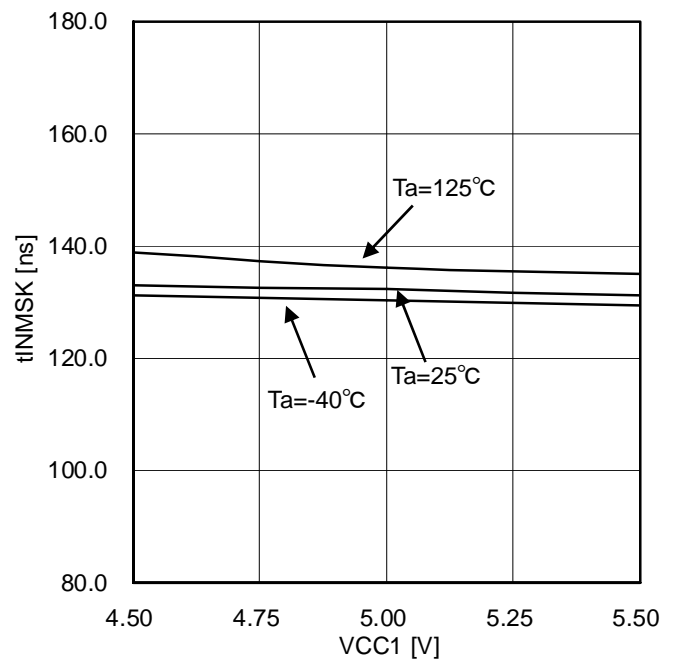

Figure 34. Logic (INA/INB) input mask time (Low pulse)

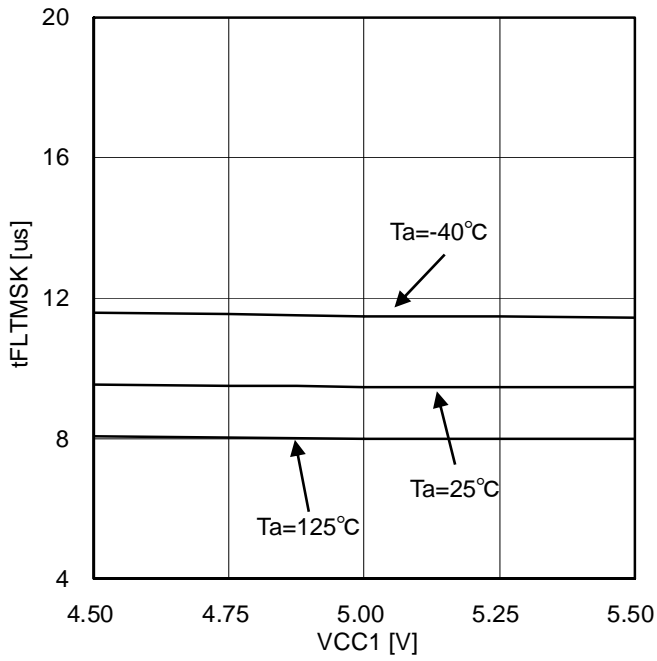

Figure 35. ENA input mask time

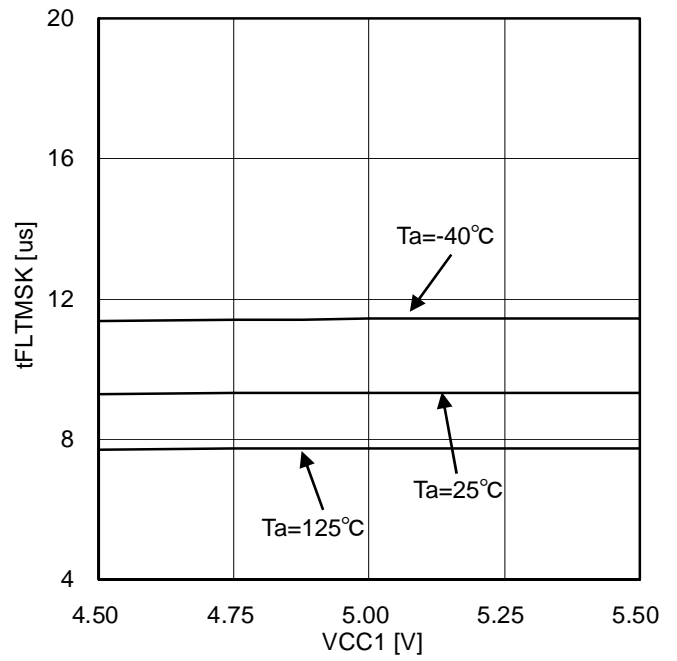

Figure 36. FLT input mask time

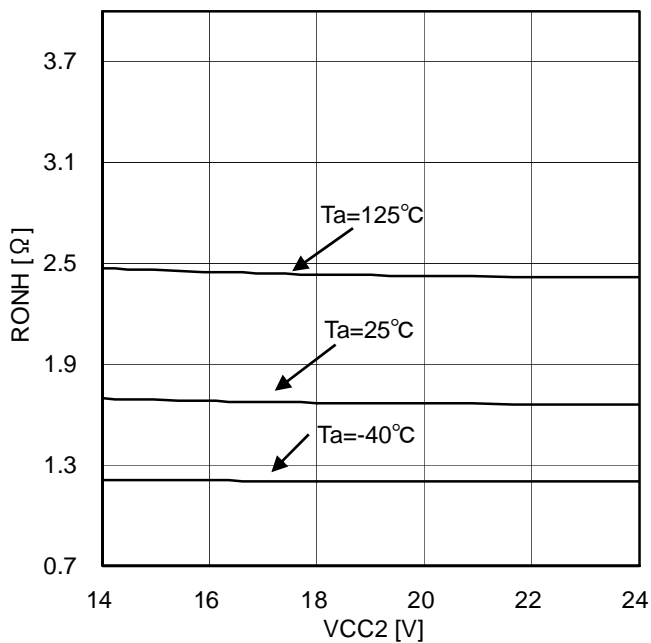

Figure 37. OUT1 ON resistance (Source)

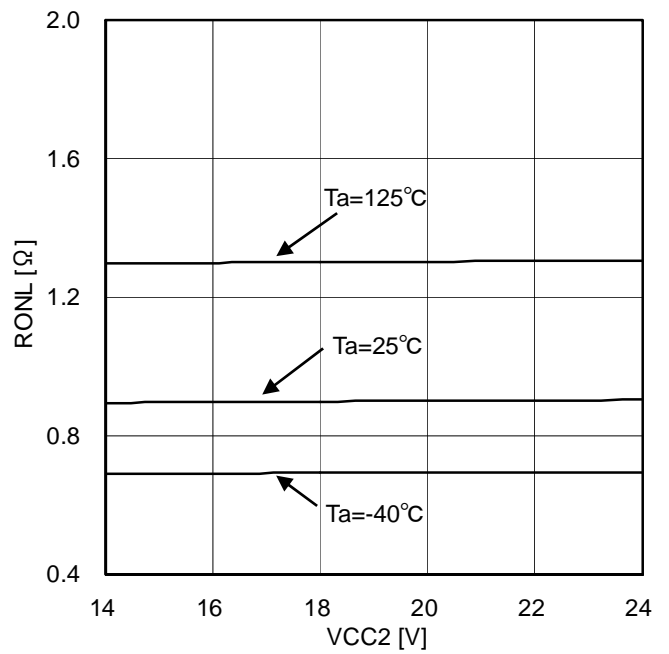

Figure 38. OUT1 ON resistance (Sink)

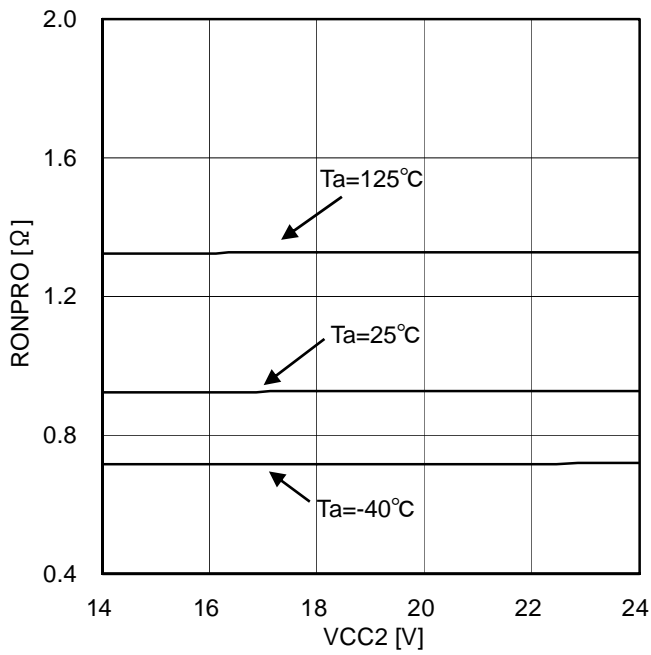

Figure 39. PROOUT ON resistance

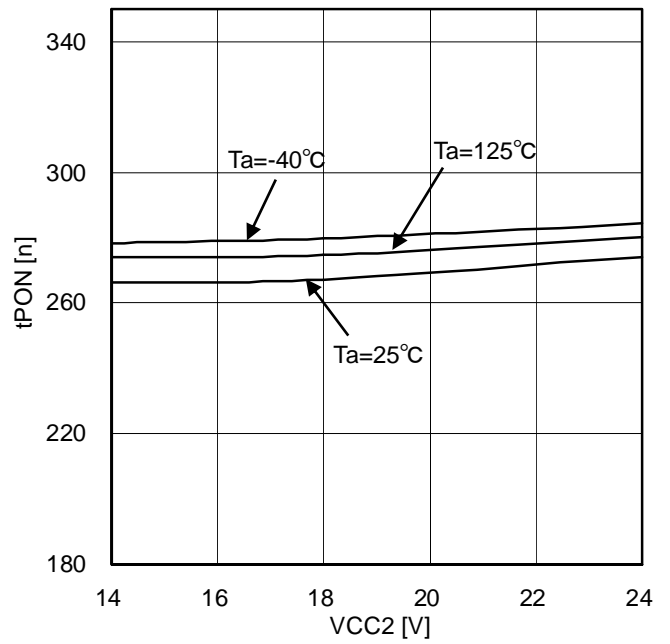

Figure 40. Turn ON time

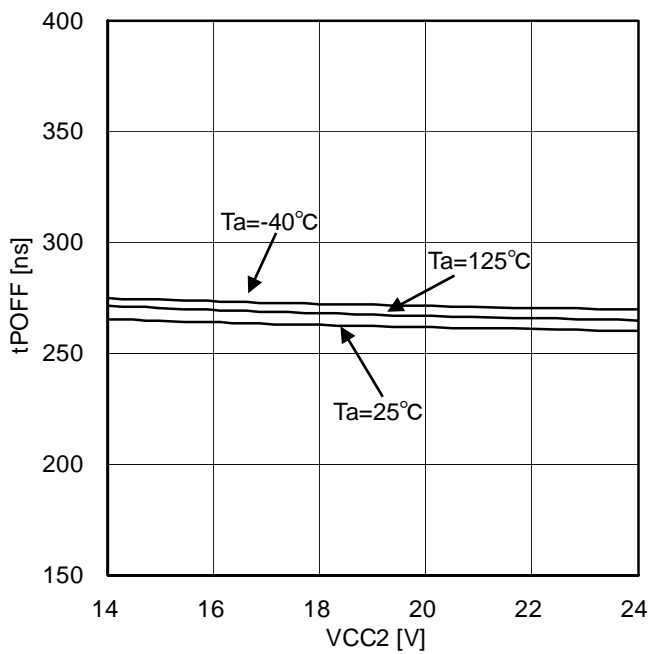

Figure 41. Turn OFF time

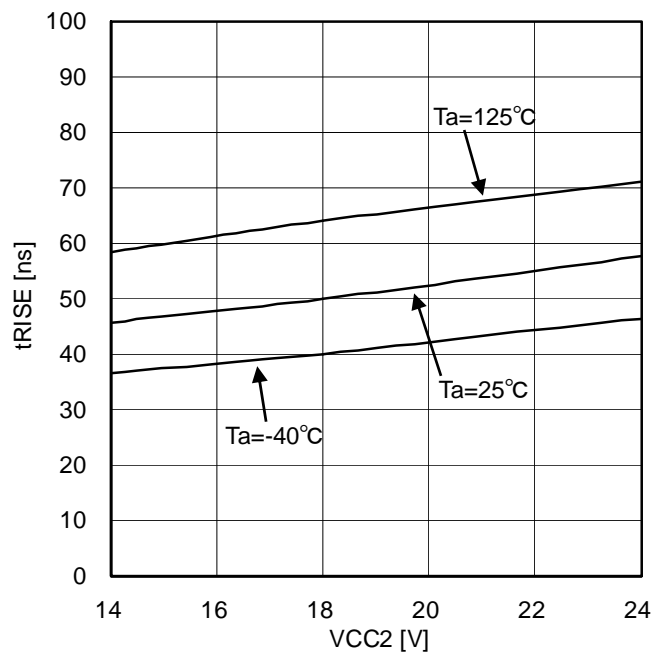

Figure 42. Rise time (10nF between OUT1-VEE2)

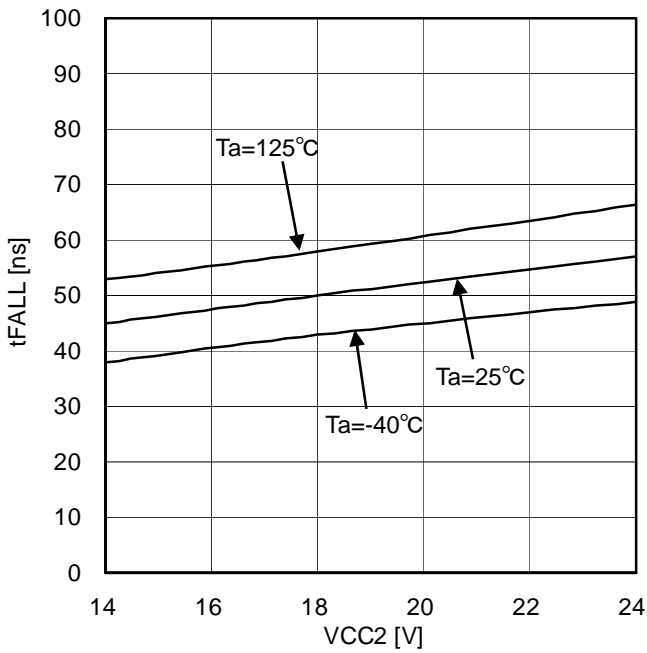

Figure 43. Fall time (10nF between OUT1-VEE2)

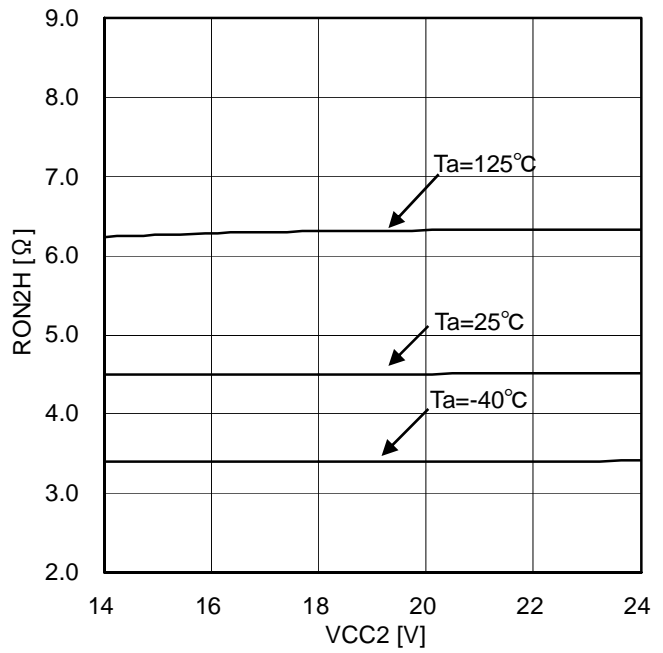

Figure 44. OUT2 ON resistance (Source)

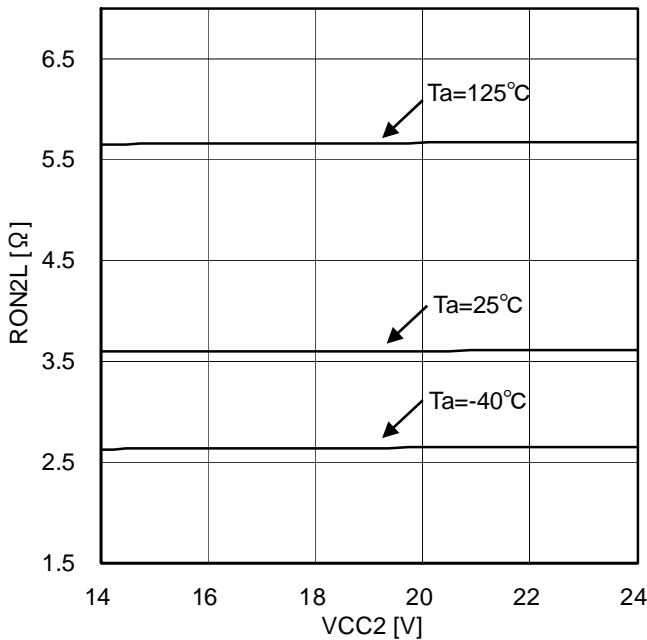

Figure 45. OUT2 ON resistance (Sink)

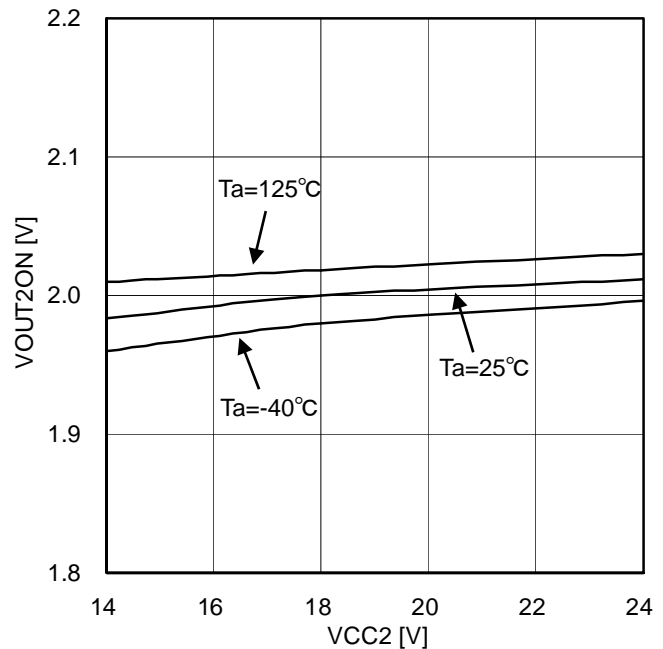

Figure 46. OUT2 ON threshold voltage

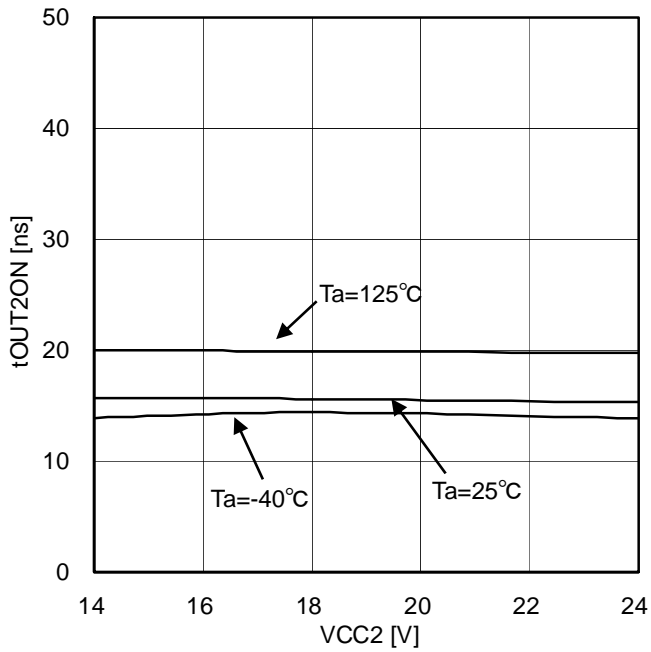

Figure 47. OUT2 output delay time

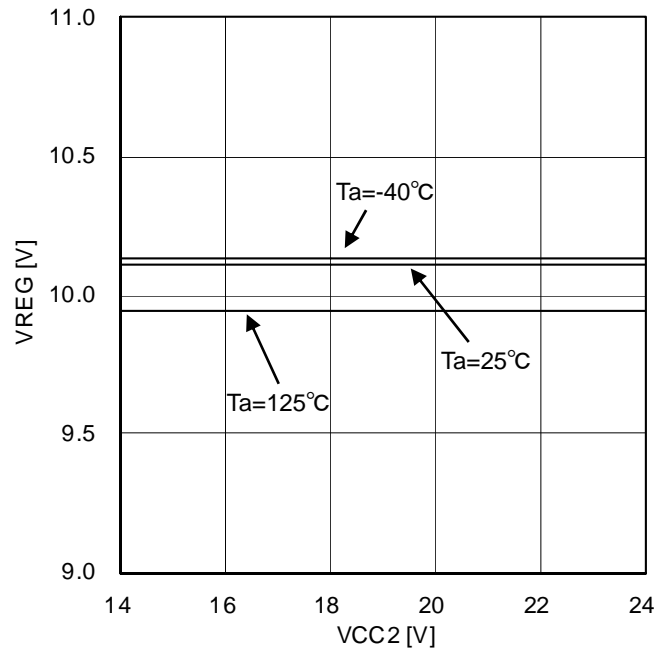

Figure 48. VREG output voltage

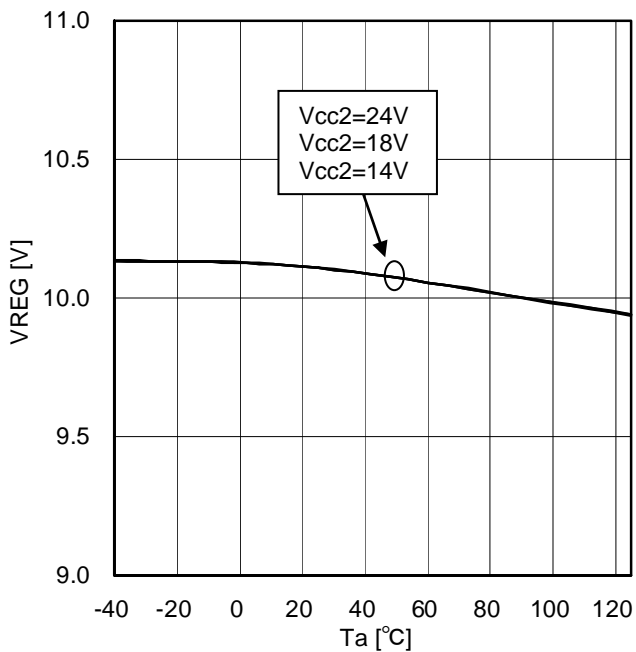

Figure 49. VREG output voltage

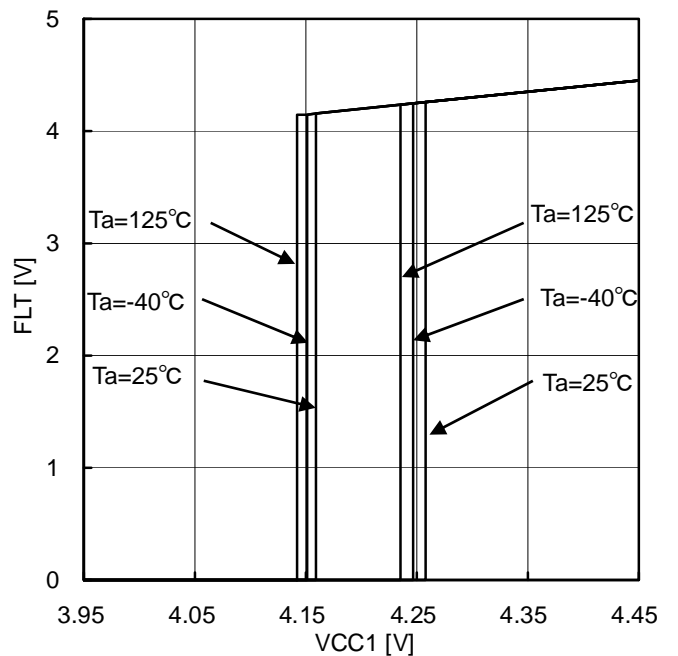

Figure 50. VCC1 UVLO ON/OFF voltage

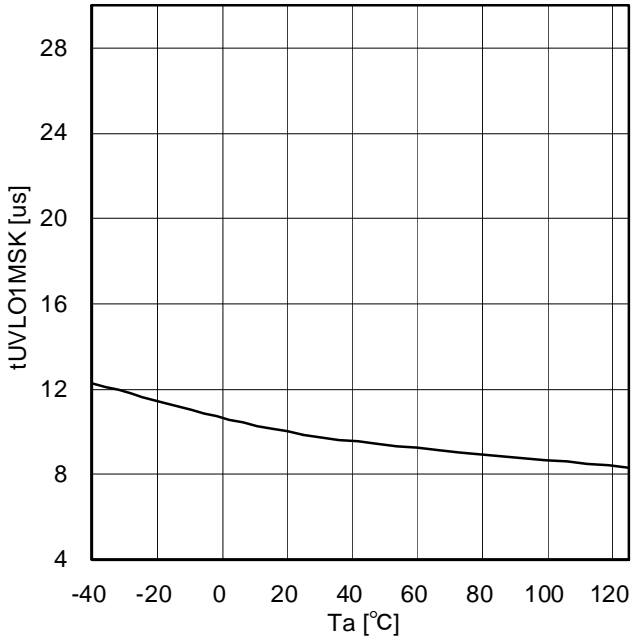

Figure 51. VCC1 UVLO mask time

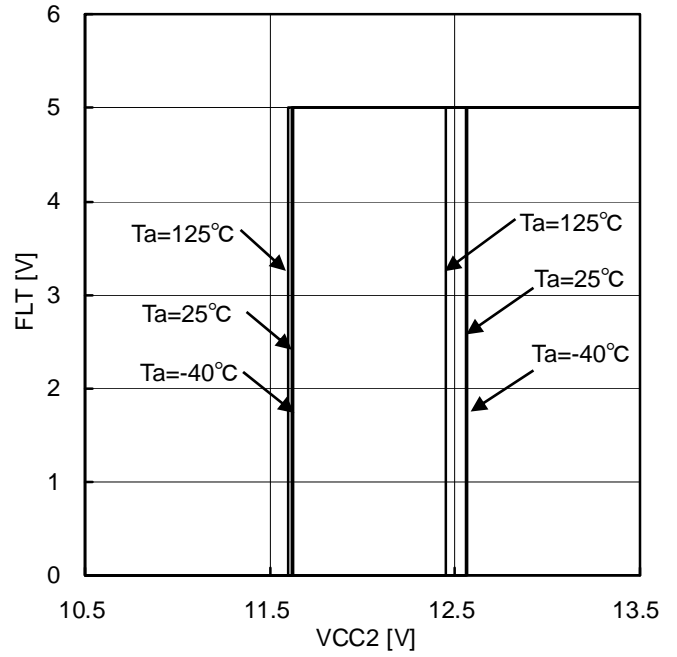

Figure 52. VCC2 UVLO ON/OFF voltage (at VCC1=5V)

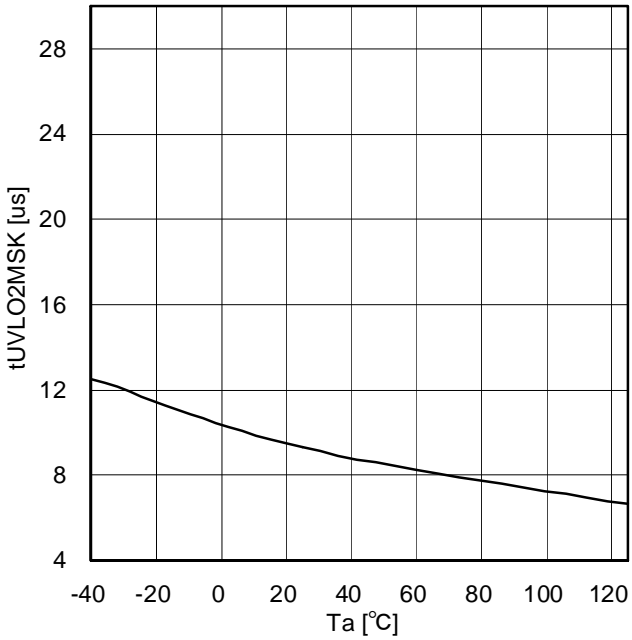

Figure 53. VCC2 UVLO mask time

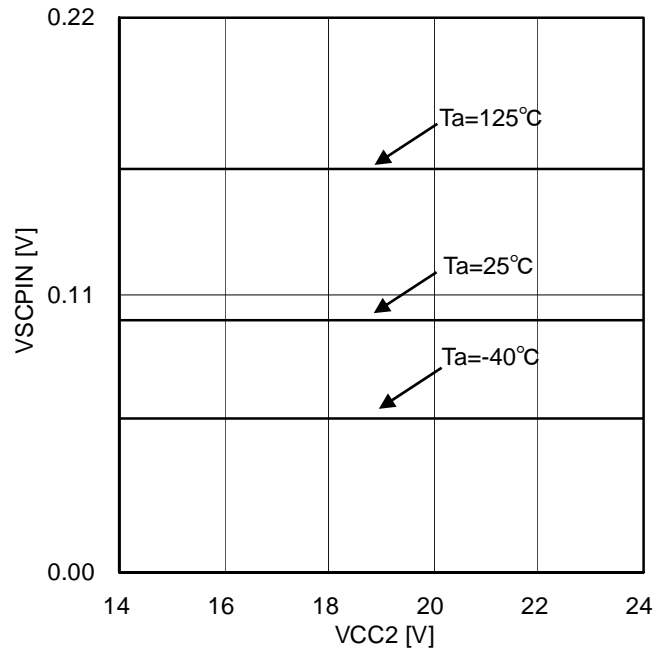

Figure 54. SCPIN input voltage (at ISCPIN=1mA)

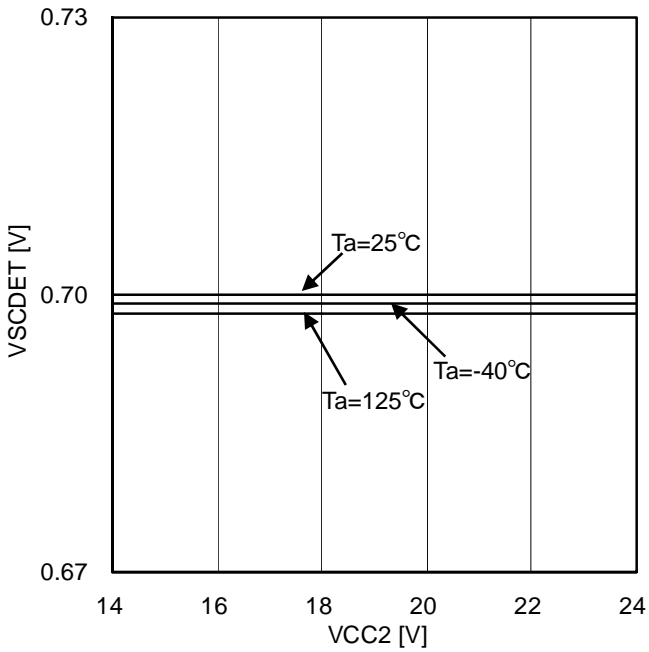

Figure 55. SCP detection voltage

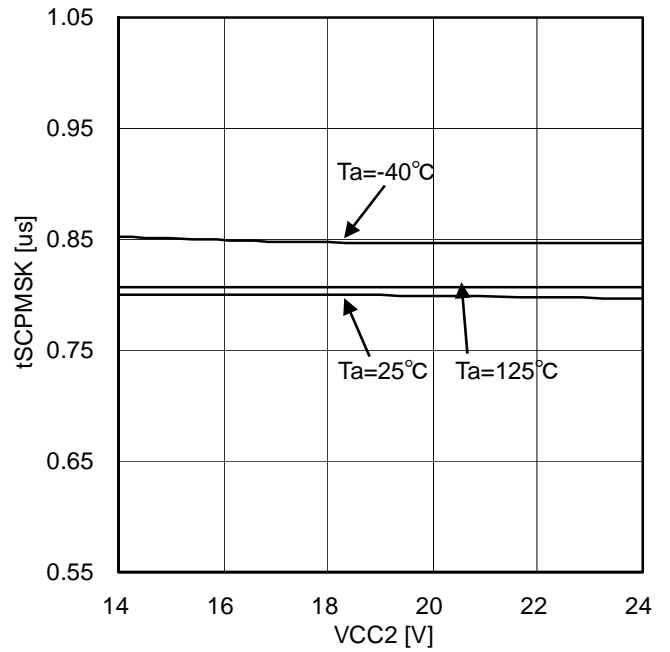

Figure 56. SCP detection mask time

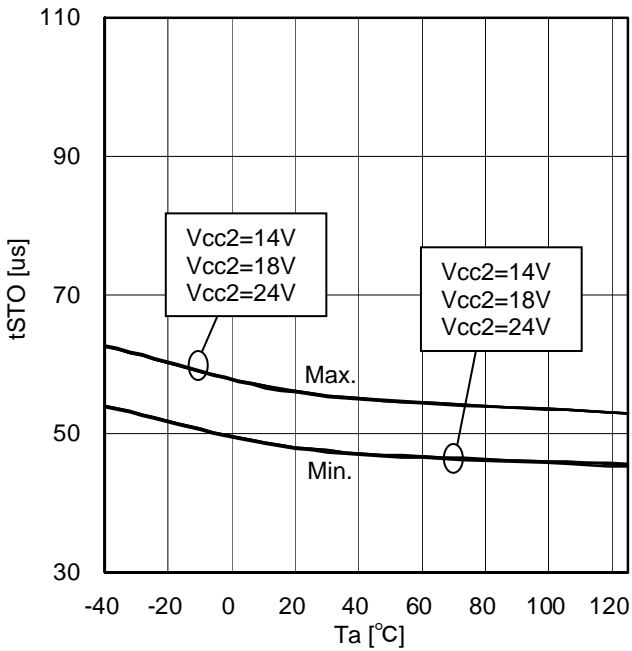

Figure 57. Soft turn OFF release time

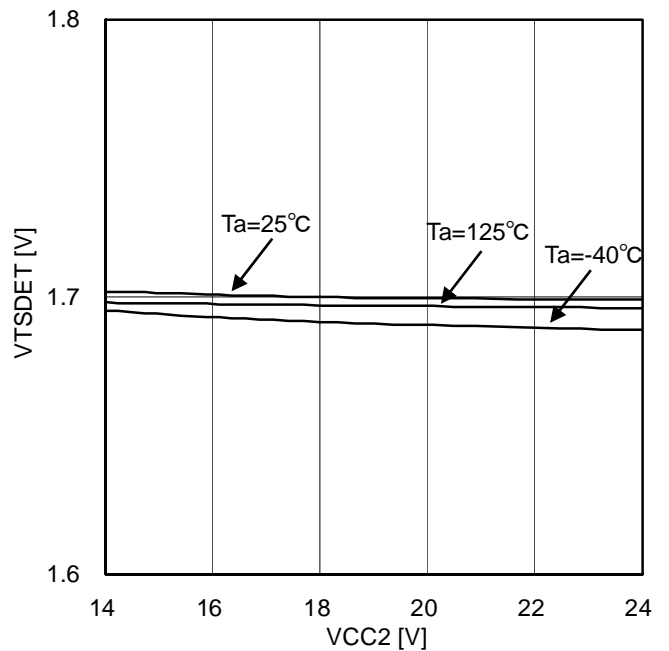

Figure 58. Thermal detection voltage

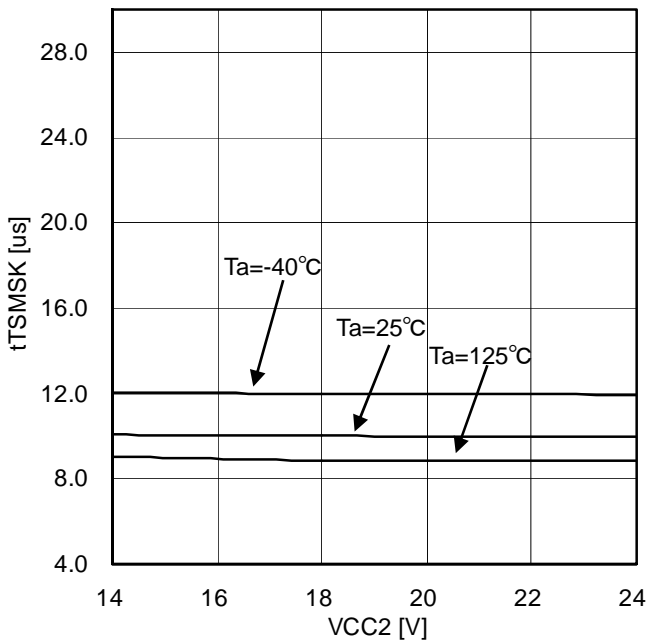

Figure 59. Thermal detection mask time

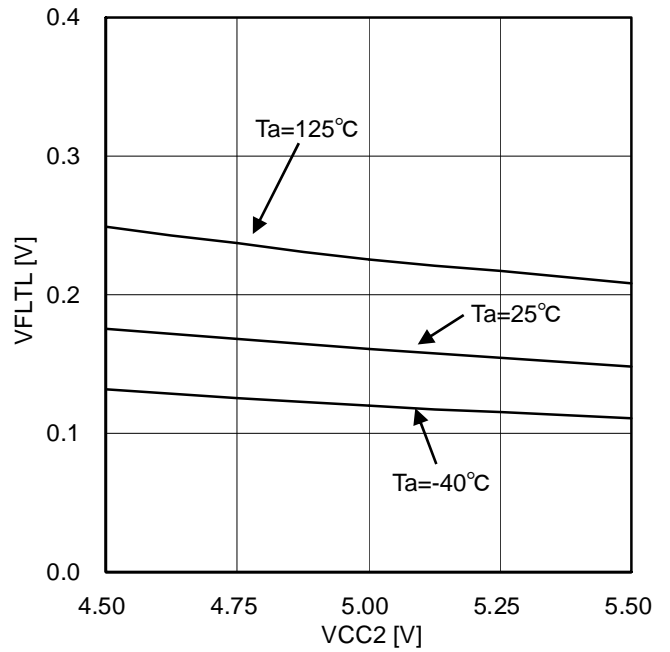

Figure 60. FLT output low voltage (IFLT=5mA)

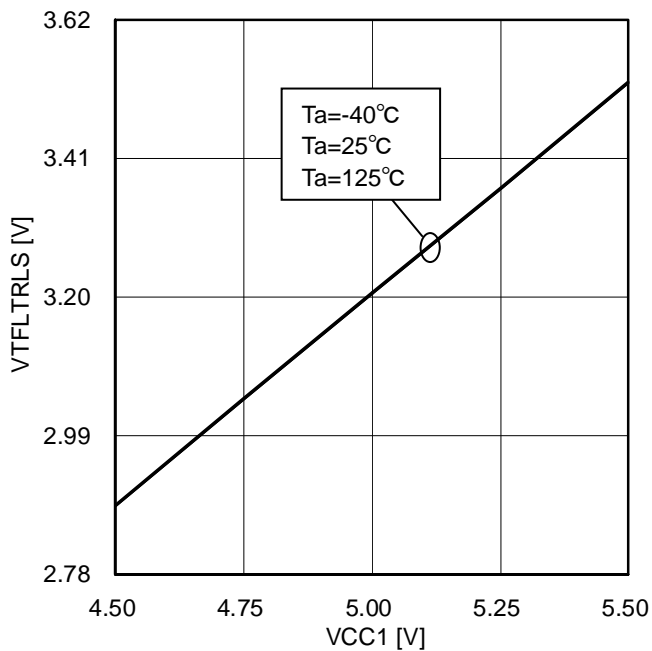

Figure 61. FLTRLS threshold





●Power Dissipation

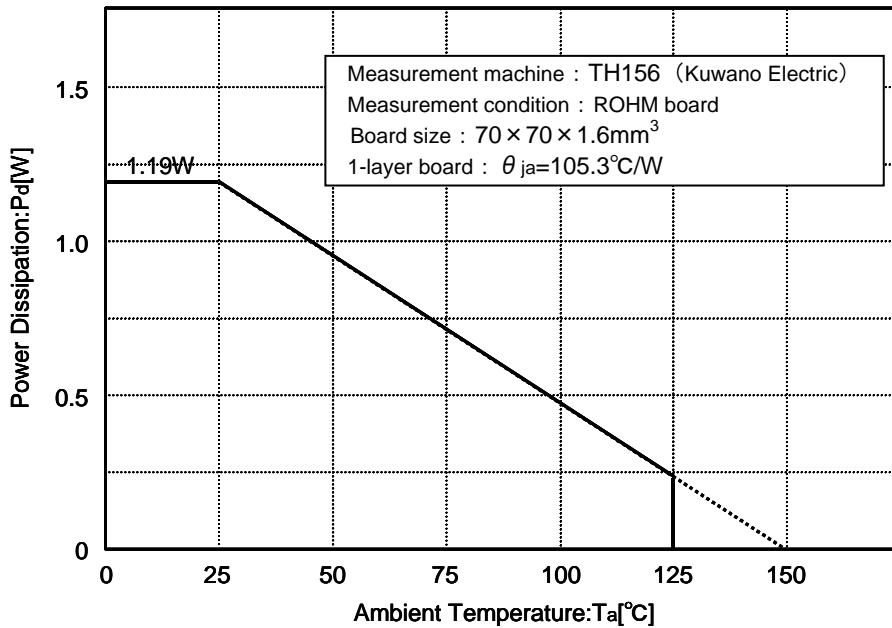

Figure 64. SSOP-B20W Derating Curve

●Thermal design

Please design that the IC's chip temperature Tj is not over 150°C, while considering the IC's power consumption (W), package power (Pd) and ambient temperature (Ta). When Tj=150°C is exceeded the functions as a semiconductor do not operate and some problems (ex. Abnormal operation of various parasitic elements and increasing of leak current) occur. Constant use under these circumstances leads to deterioration and eventually IC may destruct. Tjmax=150°C must be strictly obeyed under all circumstances.

The IC's consumed power (P) can be estimated roughly with following equation.

$$P = V_{CC1} \cdot I_{CC1} + V_{CC2} \cdot I_{GND2} + (V_{CC2} + V_{EE2}) \cdot (I_{CC2} - I_{GND2}) + I_{ON}^2 \cdot R_{ONH} \cdot t_{ON} \cdot f_{PWM} + I_{OFF}^2 \cdot R_{ONL} \cdot t_{OFF} \cdot f_{PWM}$$

f<sub>PWM</sub> : PWM frequency

I<sub>ON</sub> : OUT pin outflow current when OUT is H state.

t<sub>ON</sub> : Current outflow time from OUT pin when OUT is H state.

I<sub>OFF</sub> : OUT pin inflow current when OUT is L state.

t<sub>OFF</sub> : Current inflow time to OUT pin when OUT is L state.

● I/O equivalence circuits

Pin No.	Name	I/O equivalence circuits
	Function	
1	VTSIN	
	Thermal detection pin	
4	SCPIN	
	Short current detection pin	
5	OUT2	
	MOS FET control pin for Miller Clamp	
6	VREG	
	Power supply pin for driving MOS FET for Miller Clamp	
8	OUT	
	Output pin	
10	PROOUT	
	Soft turn-off pin	

Pin No.	Name	I/O equivalence circuits
	Function	
14	FLTRLS	
	Fault output holding time setting pin	
16	FLT	
	Fault output pin	
13	INB	
	Invert / non-invert selection pin	
17	INA	
	Control input pin	
18	ENA	
	Input enabling signal input pin	
19	TEST	
	Test mode setting pin	

●Operational Notes

- (1) Absolute maximum ratings  
An excess in the absolute maximum ratings, such as supply voltage, temperature range of operating conditions, etc., can break down the devices, thus making impossible to identify breaking mode, such as a short circuit or an open circuit. If any over rated values will expect to exceed the absolute maximum ratings, consider adding circuit protection devices, such as fuses.
- (2) Connecting the power supply connector backward  
Connecting of the power supply in reverse polarity can damage IC. Take precautions when connecting the power supply lines. An external direction diode can be added.
- (3) Power supply Lines  
Design PCB layout pattern to provide low impedance GND and supply lines. To obtain a low noise ground and supply line, separate the ground section and supply lines of the digital and analog blocks. Furthermore, for all power supply terminals to ICs, connect a capacitor between the power supply and the GND terminal. When applying electrolytic capacitors in the circuit, not that capacitance characteristic values are reduced at low temperatures.
- (4) GND1 Potential  
The potential of GND1 pin must be minimum potential in all operating conditions. (Input side ; 11pin to 20pin)
- (5) VEE2 Potential  
The potential of VEE2 pin must be minimum potential in all operating conditions. (Output side ; 1pin to 10pin)
- (6) Thermal design  
Use a thermal design that allows for a sufficient margin in light of the power dissipation (Pd) in actual operating conditions.
- (7) Inter-pin shorts and mounting errors  
When attaching to a printed circuit board, pay close attention to the direction of the IC and displacement. Improper attachment may lead to destruction of the IC. There is also possibility of destruction from short circuits which can be caused by foreign matter entering between outputs or an output and the power supply or GND.
- (8) Operation in a strong electric field  
Use caution when using the IC in the presence of a strong electromagnetic field as doing so may cause the IC to malfunction.
- (9) Inspection of the application board  
During inspection of the application board, if a capacitor is connected to a pin with low impedance there is a possibility that it could cause stress to the IC, therefore an electrical discharge should be performed after each process. Also, as a measure again electrostatic discharge, it should be earthed during the assembly process and special care should be taken during transport or storage. Furthermore, when connecting to the jig during the inspection process, the power supply should first be turned off and then removed before the inspection.
- (10) Input terminal of IC

Between each element there is a P+ isolation for element partition and a P substrate. This P layer and each element's N layer make up the P-N junction, and various parasitic elements are made up.

For example, when the resistance and transistor are connected to the terminal as shown in figure 65,

○When GND > (Terminal A) at the resistance and GND > (Terminal B) at the transistor (NPN), the P-N junction operates as a parasitic diode.

○Also, when GND > (Terminal B) at the transistor (NPN), The parasitic NPN transistor operates with the N layers of other elements close to the aforementioned parasitic diode.

Because of the IC's structure, the creation of parasitic elements is inevitable from the electrical potential relationship. The operation of parasitic elements causes interference in circuit operation, and can lead to malfunction and destruction. Therefore, be careful not to use it in a way which causes the parasitic elements to operate, such as by applying voltage that is lower than the GND (P substrate) to the input terminal.

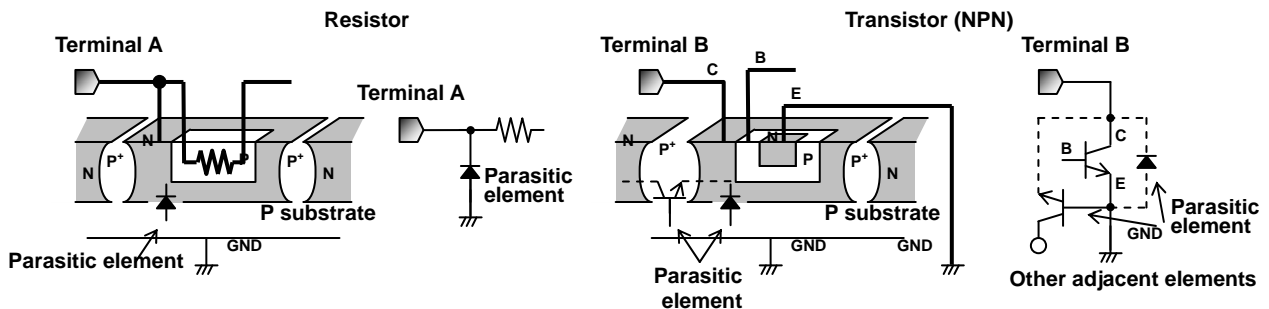
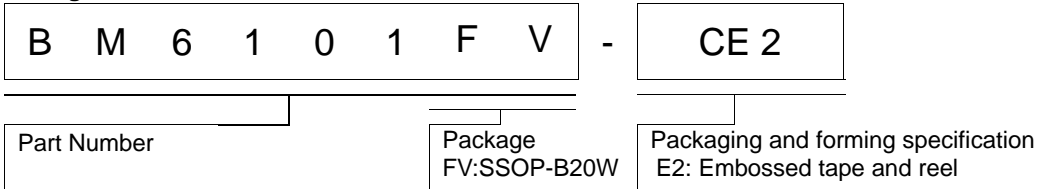

Figure 65. Pattern Diagram of Parasitic Element

(11) Ground Wiring Patterns

When using both small signal and large current GND patterns, it is recommended to isolate the two ground patterns, placing a single ground point at the application's reference point so that the pattern wiring resistance and voltage variations caused by large currents do not cause variations in the small signal ground voltage. Be careful not to change the GND wiring pattern potential of any external components, either.

●Ordering Information



●Physical Dimension Tape and Reel Information

SSOP-B20W

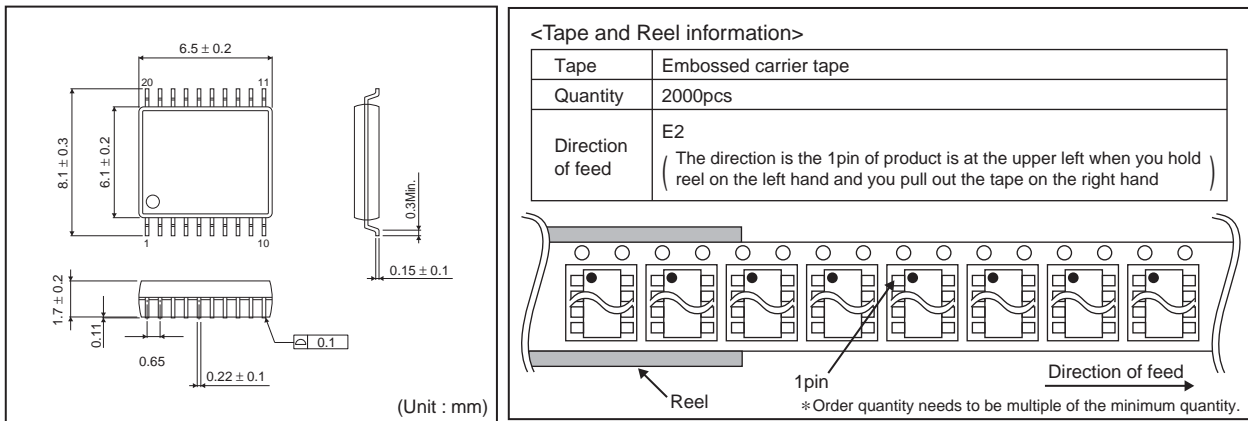

●Marking Diagram

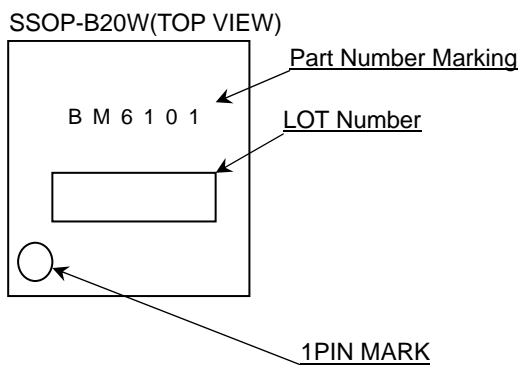

●Revision History

Date	Revision	Changes
24.Jun.2013	001	New Release

# Notice

## ●General Precaution

- 1) Before you use our Products, you are requested to carefully read this document and fully understand its contents. ROHM shall not be in any way responsible or liable for failure, malfunction or accident arising from the use of any ROHM's Products against warning, caution or note contained in this document.
- 2) All information contained in this document is current as of the issuing date and subject to change without any prior notice. Before purchasing or using ROHM's Products, please confirm the latest information with a ROHM sales representative.

## ●Precaution on using ROHM Products

- 1) Our Products are designed and manufactured for application in ordinary electronic equipments (such as AV equipment, OA equipment, telecommunication equipment, home electronic appliances, amusement equipment, etc.). If you intend to use our Products in devices requiring extremely high reliability (such as medical equipment, transport equipment, traffic equipment, aircraft/spacecraft, nuclear power controllers, fuel controllers, car equipment including car accessories, safety devices, etc.) and whose malfunction or failure may cause loss of human life, bodily injury or serious damage to property ("Specific Applications"), please consult with the ROHM sales representative in advance. Unless otherwise agreed in writing by ROHM in advance, ROHM shall not be in any way responsible or liable for any damages, expenses or losses incurred by you or third parties arising from the use of any ROHM's Products for Specific Applications.
- 2) ROHM designs and manufactures its Products subject to strict quality control system. However, semiconductor products can fail or malfunction at a certain rate. Please be sure to implement, at your own responsibilities, adequate safety measures including but not limited to fail-safe design against the physical injury, damage to any property, which a failure or malfunction of our Products may cause. The following are examples of safety measures:
  - [a] Installation of protection circuits or other protective devices to improve system safety
  - [b] Installation of redundant circuits to reduce the impact of single or multiple circuit failure
- 3) Our Products are designed and manufactured for use under standard conditions and not under any special or extraordinary environments or conditions, as exemplified below. Accordingly, ROHM shall not be in any way responsible or liable for any damages, expenses or losses arising from the use of any ROHM's Products under any special or extraordinary environments or conditions. If you intend to use our Products under any special or extraordinary environments or conditions (as exemplified below), your independent verification and confirmation of product performance, reliability, etc. prior to use, must be necessary:
  - [a] Use of our Products in any types of liquid, including water, oils, chemicals, and organic solvents
  - [b] Use of our Products outdoors or in places where the Products are exposed to direct sunlight or dust
  - [c] Use of our Products in places where the Products are exposed to sea wind or corrosive gases, including Cl<sub>2</sub>, H<sub>2</sub>S, NH<sub>3</sub>, SO<sub>2</sub>, and NO<sub>2</sub>
  - [d] Use of our Products in places where the Products are exposed to static electricity or electromagnetic waves
  - [e] Use of our Products in proximity to heat-producing components, plastic cords, or other flammable items
  - [f] Sealing or coating our Products with resin or other coating materials
  - [g] Use of our Products without cleaning residue of flux (even if you use no-clean type fluxes, cleaning residue of flux is recommended); or Washing our Products by using water or water-soluble cleaning agents for cleaning residue after soldering
  - [h] Use of the Products in places subject to dew condensation
- 4) The Products are not subject to radiation-proof design.
- 5) Please verify and confirm characteristics of the final or mounted products in using the Products.
- 6) In particular, if a transient load (a large amount of load applied in a short period of time, such as pulse) is applied, confirmation of performance characteristics after on-board mounting is strongly recommended. Avoid applying power exceeding normal rated power; exceeding the power rating under steady-state loading condition may negatively affect product performance and reliability.
- 7) De-rate Power Dissipation (Pd) depending on Ambient temperature (Ta). When used in sealed area, confirm the actual ambient temperature.
- 8) Confirm that operation temperature is within the specified range described in the product specification.
- 9) ROHM shall not be in any way responsible or liable for failure induced under deviant condition from what is defined in this document.



● **Precaution for Mounting / Circuit board design**

- 1) When a highly active halogenous (chlorine, bromine, etc.) flux is used, the residue of flux may negatively affect product performance and reliability.
- 2) In principle, the reflow soldering method must be used; if flow soldering method is preferred, please consult with the ROHM representative in advance.

For details, please refer to ROHM Mounting specification

● **Precautions Regarding Application Examples and External Circuits**

- 1) If change is made to the constant of an external circuit, please allow a sufficient margin considering variations of the characteristics of the Products and external components, including transient characteristics, as well as static characteristics.
- 2) You agree that application notes, reference designs, and associated data and information contained in this document are presented only as guidance for Products use. Therefore, in case you use such information, you are solely responsible for it and you must exercise your own independent verification and judgment in the use of such information contained in this document. ROHM shall not be in any way responsible or liable for any damages, expenses or losses incurred by you or third parties arising from the use of such information.

● **Precaution for Electrostatic**

This Product is electrostatic sensitive product, which may be damaged due to electrostatic discharge. Please take proper caution in your manufacturing process and storage so that voltage exceeding the Products maximum rating will not be applied to Products. Please take special care under dry condition (e.g. Grounding of human body / equipment / solder iron, isolation from charged objects, setting of Ionizer, friction prevention and temperature / humidity control).

● **Precaution for Storage / Transportation**

- 1) Product performance and soldered connections may deteriorate if the Products are stored in the places where:
  - [a] the Products are exposed to sea winds or corrosive gases, including Cl<sub>2</sub>, H<sub>2</sub>S, NH<sub>3</sub>, SO<sub>2</sub>, and NO<sub>2</sub>
  - [b] the temperature or humidity exceeds those recommended by ROHM
  - [c] the Products are exposed to direct sunshine or condensation
  - [d] the Products are exposed to high Electrostatic
- 2) Even under ROHM recommended storage condition, solderability of products out of recommended storage time period may be degraded. It is strongly recommended to confirm solderability before using Products of which storage time is exceeding the recommended storage time period.
- 3) Store / transport cartons in the correct direction, which is indicated on a carton with a symbol. Otherwise bent leads may occur due to excessive stress applied when dropping of a carton.
- 4) Use Products within the specified time after opening a humidity barrier bag. Baking is required before using Products of which storage time is exceeding the recommended storage time period.

● **Precaution for Product Label**

QR code printed on ROHM Products label is for ROHM's internal use only.

● **Precaution for Disposition**

When disposing Products please dispose them properly using an authorized industry waste company.

● **Precaution for Foreign Exchange and Foreign Trade act**

Since our Products might fall under controlled goods prescribed by the applicable foreign exchange and foreign trade act, please consult with ROHM representative in case of export.

● **Precaution Regarding Intellectual Property Rights**

- 1) All information and data including but not limited to application example contained in this document is for reference only. ROHM does not warrant that foregoing information or data will not infringe any intellectual property rights or any other rights of any third party regarding such information or data. ROHM shall not be in any way responsible or liable for infringement of any intellectual property rights or other damages arising from use of such information or data.:
- 2) No license, expressly or implied, is granted hereby under any intellectual property rights or other rights of ROHM or any third parties with respect to the information contained in this document.

● **Other Precaution**

- 1) The information contained in this document is provided on an "as is" basis and ROHM does not warrant that all information contained in this document is accurate and/or error-free. ROHM shall not be in any way responsible or liable for any damages, expenses or losses incurred by you or third parties resulting from inaccuracy or errors of or concerning such information.
- 2) This document may not be reprinted or reproduced, in whole or in part, without prior written consent of ROHM.
- 3) The Products may not be disassembled, converted, modified, reproduced or otherwise changed without prior written consent of ROHM.
- 4) In no event shall you use in any way whatsoever the Products and the related technical information contained in the Products or this document for any military purposes, including but not limited to, the development of mass-destruction weapons.
- 5) The proper names of companies or products described in this document are trademarks or registered trademarks of ROHM, its affiliated companies or third parties.